

20

Verschiedenes

Miscellaneous

Articles divers

Diversos artículos

Articoli diversi





Bleihände

Lead hands

Manches en plomb

Manos de plomo

Mani di piombo



1:3

67-970-001

für Kinder
for children
pour enfants
para niños
per bambini

67-970-002

für Erwachsene
for adults
pour adultes
para adultos
per adulti



1:3

67-790-003

für Kinder, mit Silikonüberzug
child size with silicone coating
pour enfants, avec couche de silicone
para niños, con cubierta de silicon
per bambini, rivestito di silicone

67-790-004

für Erwachsene, mit Silikonüberzug
adult size with silicone coating
pour adultes, avec couche de silicon
para adultos, con cubierta de silicon
per adulti, rivestito di silicone

Instrumente für Finger- und Zehennägel
Nail instruments

Instruments à ongles
Instrumentos para uñas
Strumenti per unghie



1:2

FELDHEIM

100 mm – 4 "	423-960-100
--------------	-------------

Finger- und Zehenkompressorium

Tourniquet for fingers and toes
Tourniquet pour doigts des mains et pieds
Torniquete para los dedos de manos y pies
Compressorio per dita di mano e piede



1:2



1:1



1:1



1:1

	Fig. 1	Fig. 2	Fig. 3	Fig. 1, Fig. 2, Fig. 3
67-974-000	333-156-010/1	333-156-010/2	333-156-010/3	333-156-010

komplett mit Fig. 1 – 3
complete with Fig. 1 – 3
complet avec Fig. 1 – 3
completa con Fig. 1 – 3
completo con Fig. 1 – 3

Satz
Set
Jeu
Juego
Serie



1:2

RADOLF

135 mm – 5 ¼ "	67-978-140
----------------	------------

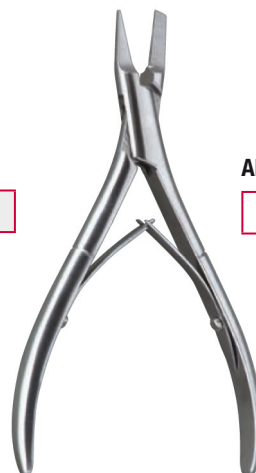
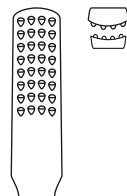

1:2

ANVIL

135 mm – 5 ¼ "	441-816-135
----------------	-------------



Fingerringsägen
Finger ring saws

Scies pour couper des bagues
Sierras para abrir anillos
Seghe per anelli



1:2

170 mm – 6¾"	
67-982-000	67-983-000

Sägeblatt allein
Blade only
Lame seule
Hoja sola
Lama sola



1:2

WALTON

160 mm – 6¼"	
67-980-000	67-981-000

Sägeblatt allein
Blade only
Lame seule
Hoja sola
Lama sola



1:2

170 mm – 6¾"	
333-171-000	333-171-010

Sägeblatt allein
Blade only
Lame seule
Hoja sola
Lama sola

Lupuslöffel
Lupus curettes

Curettes pour les lupus
Curetas para lupus
Curette per lupus

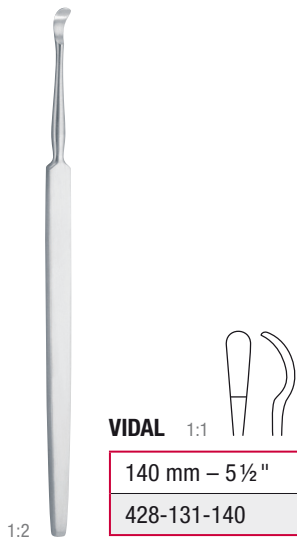

VIDAL	1:1
140 mm – 5 ½"	
428-131-140	

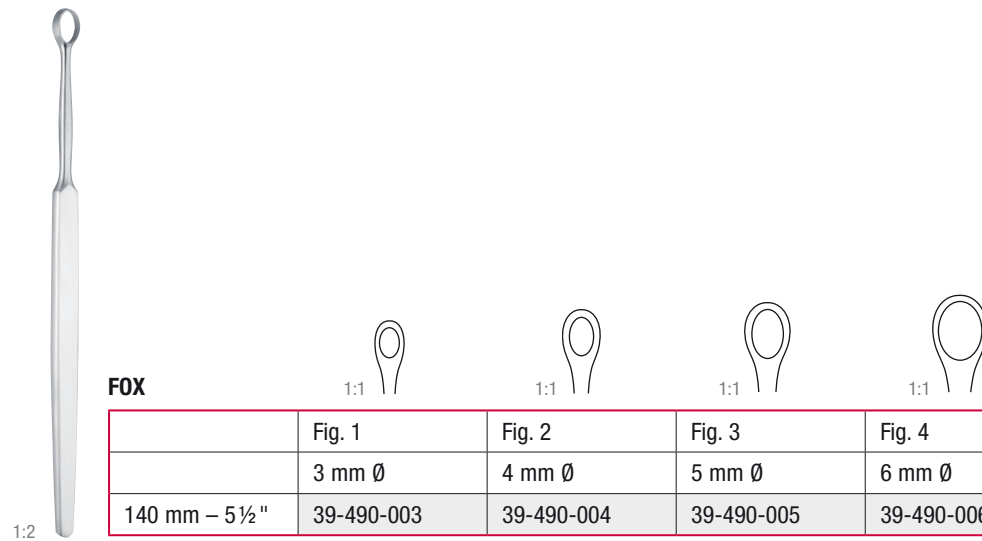

FOX	Fig. 1	Fig. 2	Fig. 3	Fig. 4
	3 mm Ø	4 mm Ø	5 mm Ø	6 mm Ø
140 mm – 5 ½"	39-490-003	39-490-004	39-490-005	39-490-006

Verschiedenes

Miscellaneous



Häkchen
Hooklets
Crochets
Ganchos
Uncini



WOLFF

1:2



1:1



1:1



1:1



1:1



1:1



1:1

	Fig. 1	Fig. 2	Fig. 3	Fig. 4	Fig. 5	Fig. 6
140 mm-5½"	428-192-010	428-192-020	428-192-030	428-192-040	428-192-050	428-192-060

Trephinen
Trephines
Trépan
Trépanos
Trefine



1:2

KEYES



	Fig. 1	Fig. 2	Fig. 3	Fig. 4	Fig. 5	Fig. 6	Fig. 7
	2 mm Ø	3 mm Ø	4 mm Ø	5 mm Ø	6 mm Ø	7 mm Ø	8 mm Ø
120 mm – 4 3/4"	39-200-002	39-200-003	39-200-004	39-200-005	39-200-006	39-200-007	39-200-008



1:1

KEYES

374-134-000

Hautstanze – komplett mit 6 auswechselbaren Aufsätzen, Ø 2 mm – 7 mm
Punch – complete with 6 interchangeable tips, Ø 2 mm – 7 mm
Poinçon – complet avec 6 pointes interchangeables, Ø 2 mm – 7 mm
Punzón – completo con 6 puntas intercambiables, Ø 2 mm – 7 mm
Punzone – completo con 6 testine intercambiabili, Ø 2 mm – 7 mm

KEYES



	2 mm Ø	3 mm Ø	4 mm Ø	5 mm Ø	6 mm Ø	7 mm Ø
120 mm – 4 3/4"	374-134-002	374-134-003	374-134-004	374-134-005	374-134-006	374-134-007

Aufsätze
Tips
Pointes
Puntas
Testine

KEYES

120 mm – 4 3/4" 374-134-001

Griff, allein
Handle, only
Manche, seul
Mango, sólo
Manico, solo



1:2

HOLTH

90 mm – 3 1/2" 2 mm 29-125-090

Hautstanze
Punch
Poinçon
Punzón
Punzone

Verschiedenes

Miscellaneous



Komedoneninstrumente

Comedones extractors
Tire-comédons
Saca-comedones
Tiracomedoni

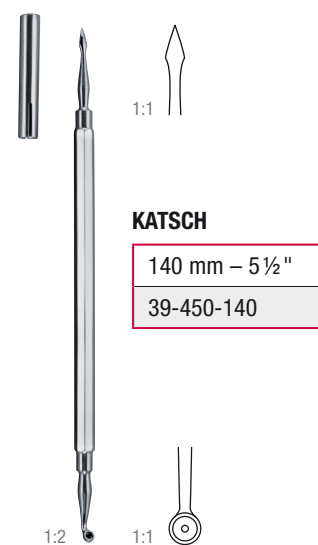
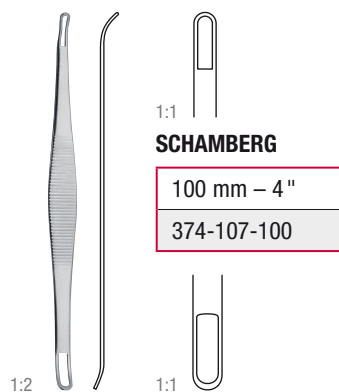
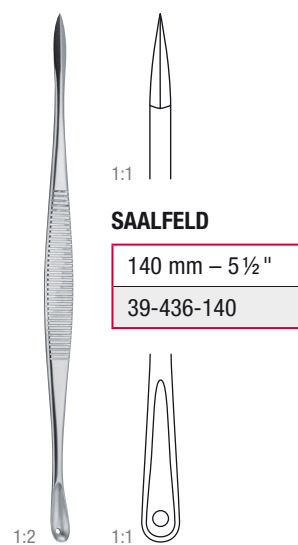
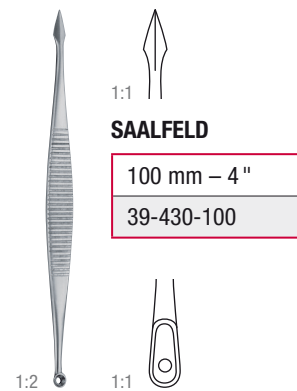
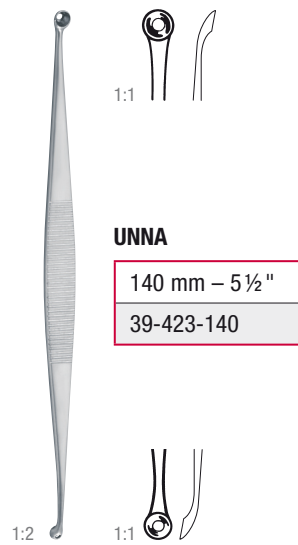
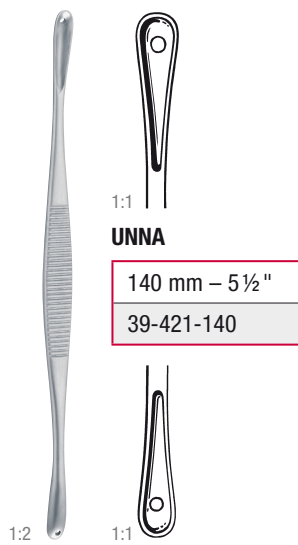

Infusionsflaschenöffnungszange
Forceps to open infusion bottles

Pince pour ouvrir des bouteilles d'infusion
Pinza para abrir botellas de infusión
Pinza apriflebo



1:2

200 mm – 8"

17-786-200

Verschiedenes Miscellaneous



20

Sterilisierzangen – Abfallzangen

Sterilizing forceps – waste forceps

Pinces à stérilisation – pincés à déchets

Pinzas de esterilización – pinzas de basuras

Pinze per sterilizzazione – pinze per rifiuti



CHEATLE

1:2

270 mm – 10¾"	17-787-270
---------------	------------

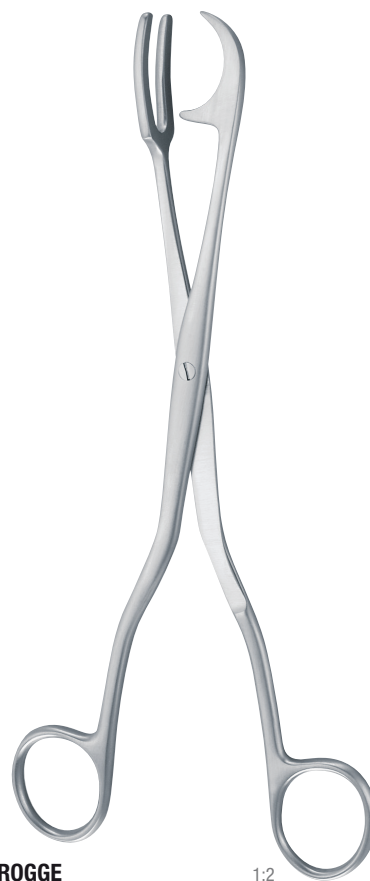

ROGGE

1:2

230 mm – 9"	17-796-230
-------------	------------

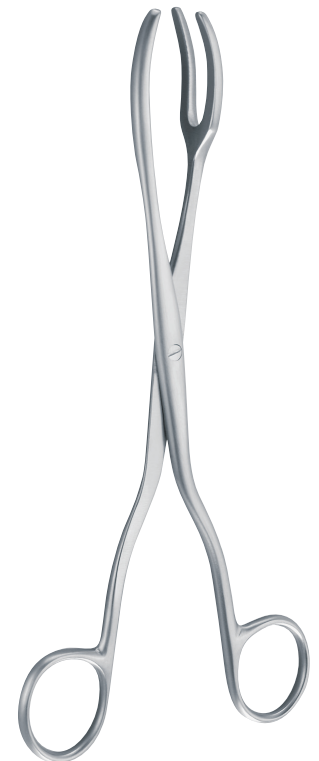

200 mm – 8"	17-791-200
-------------	------------

300 mm – 12"	17-791-300
--------------	------------

Sterilisierzangen – Sterilisierklammern – Kappenzangen
Sterilizing forceps and pins – forceps with lid

Pinces à stérilisation – pincas en boîtiers avec couvercles
Pinzas y cadres de esterilización – combinación tapa/pinza
Pinze e spille per sterilizzazione – pinze porta cotoni

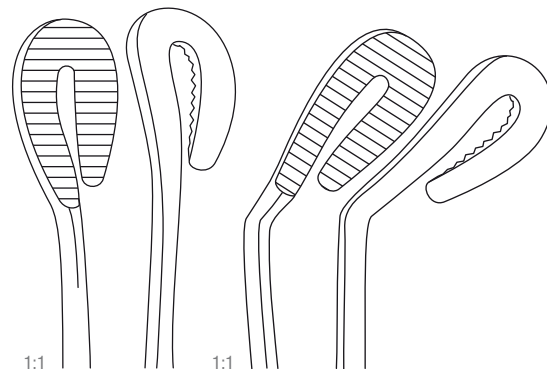

UNIVERSAL

200 mm – 8 "	17-920-200	17-921-200
280 mm – 11 "	17-920-280	17-921-280



1:3

BUNT

1:2

120 mm – 4 ¾ "	328-146-120
----------------	-------------

MAYO

1:2

140 mm – 5 ½ "	328-147-140
----------------	-------------

250 mm – 9 ¾ "	73-220-250
320 mm – 12 ½ "	73-220-320
390 mm – 15 ¼ "	73-220-390

- 1 Kornzange, gebogen, mit Sperre mit Deckel
- 1 Standgefäß mit großer, standsicherer Bodenplatte
- 1 Tampon forceps, curved, with ratchet with lid for jar
- 1 Jar with wide bottom plate
- 1 Pince à tampons, courbe, avec crémaillère
- 1 Boîtier, stable
- 1 Pinza para tampones con cremallera
- 1 Cazoleta de metal
- 1 Pinza para medicamento
- 1 Recipiente metálico

Verschiedenes Miscellaneous



20

Handwaschbürste – Bürstenspender

Hand and nail brush – brush dispensers

Brosse à ongles – distributeurs de brosses

Cepillo para uñas – dispensadores de cepillos

Spazzola per unghie – distributore per spazzole



374-394-000

Handwaschbürste

Brush
Brosse
Cepillo
Spazzola



454-146-100

für 10 Bürsten (ohne Bürsten)
for 10 brushes (without brushes)
pour 10 brosses (sans brosses)
para 10 cepillos (sin cepillos)
per 10 spazzole (senza spazzole)

mit Aufhängevorrichtung

with suspension
avec suspension
con suspensión
con suspensioe

454-146-200

für 20 Bürsten (ohne Bürsten)
for 20 brushes (without brushes)
pour 20 brosses (sans brosses)
para 20 cepillos (sin cepillos)
per 20 spazzole (senza spazzole)

mit Aufhängevorrichtung

with suspension
avec suspension
con suspensión
con suspensioe

Nadel-Sterilisierkästen

Sterilizing trays for needles

Boîtes à stérilisation des aiguilles

Cajas de esterilización para agujas

Scatole per sterilizzazione aghi

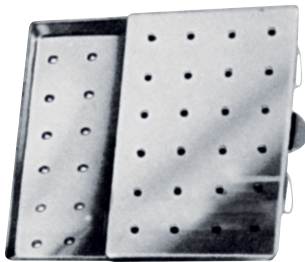

50.0 mm x 25.0 mm x 4.5 mm	73-100-050
65.0 mm x 42.0 mm x 8.0 mm	73-100-065
75.0 mm x 25.0 mm x 4.5 mm	73-100-075

18/8 rostfrei, gelocht

18/8 stainless steel, perforated
18/8 inoxydable, perforé
18/8 inoxidable, perforado
18/8 inossidabile, perforato

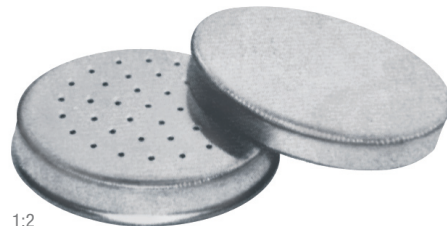

1:2

65 mm Ø x 17 mm	73-120-065
-----------------	------------

gelochte Innendose, 18/8 rostfrei

perforated insert, 18/8 stainless steel
insert perforé, 18/8 inoxydable
inserto perforado, 18/8 inoxidable
scatola interna forata, inossidabile 18/8

65 mm Ø x 17 mm	73-122-065
-----------------	------------

ungelochte Außendose, 18/8 rostfrei

outer case not perforated, 18/8 stainless steel
boîtier non perforé, 18/8 inoxydable
caja no perforada, 18/8 inoxidable
scatolo esterna non forata, inossidabile 18/8

62 mm Ø x 15 mm	73-124-062
-----------------	------------

gelochte Innendose, 18/8 rostfrei

perforated insert, 18/8 stainless steel
insert perforé, 18/8 inoxydable
inserto perforado, 18/8 inoxidable
scatola interna forata, 18/8 inossidabile



Nadel-Sterilisierkästen

Sterilizing trays for needles

Boîtes à stérilisation des aiguilles

Cajas de esterilización para agujas

Scatole per sterilizzazione aghi



150 mm x 95 mm x 13 mm	388-110-000	388-110-001	388-110-002
<p>18/8 rostfrei 18/8 stainless steel 18/8 inoxydable 18/8 inoxidable 18/8 inossidabile</p>	<p>gelocht perforated perforé perforado perforato</p>	<p>Deckel ungelocht, Boden gelocht Cover not perforated, bottom perforated Couvercle non perforé, boîtier perforé Tapa no perforado, caja perforado Coperchio non perforato, fondo perforato</p>	<p>ungelocht not perforated non perforé no perforado non perforato</p>

Verschiedene Behälter
Different containers

Boîtes diverses
Contenedores varios
Vassoi diversi



0.75 l	165 mm Ø x 60 mm	388-129-160
1.00 l	175 mm Ø x 70 mm	388-129-170
2.00 l	220 mm Ø x 80 mm	388-129-220
3.00 l	240 mm Ø x 110 mm	388-129-240
4.50 l	275 mm Ø x 115 mm	388-129-270
6.00 l	290 mm Ø x 125 mm	388-129-290
6.00 l	310 mm Ø x 120 mm	388-129-310
8.50 l	345 mm Ø x 125 mm	388-129-340
11.00 l	380 mm Ø x 130 mm	388-129-380

Schüsseln und Laborschalen, matt, 18/8 rostfrei

Bowls, tarnished, 18/8 stainless steel
Coupoles, depoli, 18/8 inoxydable
Palanganas, 18/8 inoxidable
Scodelle, inossidabile 18/8



170 mm x 95 mm x 25 mm	73-251-170
200 mm x 95 mm x 30 mm	73-251-205
250 mm x 125 mm x 35 mm	73-251-250
275 mm x 140 mm x 40 mm	73-251-275

Nierenschalen, matt, 18/8 rostfrei

Kidney bowls, tarnished, 18/8 stainless steel
Haricots, depoli, 18/8 inoxydable
Riñoneras, 18/8 inoxidable
Baccinella reniforme, 18/8 inossidabile



0.05 l	40 mm Ø x 19 mm	388-126-040
0.07 l	61 mm Ø x 30 mm	388-126-060
0.14 l	80 mm Ø x 40 mm	388-126-080
0.35 l	116 mm Ø x 50 mm	388-126-100
0.45 l	128 mm Ø x 55 mm	388-126-120
0.70 l	147 mm Ø x 65 mm	388-126-150



0,02 l	50 mm Ø x 50 mm	456-602-200
0,05 l	50 mm Ø x 50 mm	456-602-500

Medizinlöffel, graduert, matt, 18/8 rostfrei

Medicine cup, graduated, tarnished, 18/8 stainless steel
Timbale, graduée, depolie, 18/8 inoxydable
Vaso, graduado, mate, 18/8 inoxidable
Recipiente, graduato, 18/8 inossidabile



0,05 l	50 mm Ø x 50 mm	456-600-500
--------	-----------------	-------------

Medizinbecher, graduert, matt, 18/8 rostfrei

Medicine cup, graduated, tarnished, 18/8 stainless steel
Timbale, graduée, depolie, 18/8 inoxydable
Vaso, graduado, mate, 18/8 inoxidable
Recipiente, graduato, 18/8 inossidabile

Verschiedenes

Miscellaneous



20

Verschiedene Behälter

Different containers
Boîtes diverses
Contenedores varios
Vassoi diversi



30 mm Ø x 90 mm	73-200-001
50 mm Ø x 100 mm	73-200-002
50 mm Ø x 130 mm	73-200-003
50 mm Ø x 175 mm	73-200-004
75 mm Ø x 100 mm	73-200-005
75 mm Ø x 130 mm	73-200-006
75 mm Ø x 175 mm	73-200-007
100 mm Ø x 175 mm	73-200-008
100 mm Ø x 200 mm	73-200-009

18/8 rostfrei, Standgefäße, ohne Deckel
 18/8 stainless steel, mugs, without cover
 18/8 inoxydable, boîtiers, sans couvercle
 18/8 inoxidable, cilindros sin tapa
 18/8 inossidabile, recipienti cilindrici



75 mm Ø x 60 mm	73-320-001
75 mm Ø x 75 mm	73-320-002
100 mm Ø x 60 mm	73-320-003
100 mm Ø x 100 mm	73-320-004
125 mm Ø x 80 mm	73-320-005
125 mm Ø x 125 mm	73-320-006
150 mm Ø x 100 mm	73-320-010
150 mm Ø x 150 mm	73-320-011

Wattedosen mit Knopfdeckel, 18/8 rostfrei
 Dressing jars with cover, 18/8 stainless steel
 Boîtes à pansements avec couvercle, 18/8 inoxydable
 Dispensadores de algodón, 18/8 inoxidable
 Dispensori di cotone, 18/8 inossidabile



75 mm Ø x 60 mm	73-260-000
-----------------	------------

Sputumbecher, matt, 18/8 rostfrei
 Sputum mugs, tarnished, 18/8 stainless steel
 Coupes, depoli, 18/8 inoxydable
 Escupideras, mate, 18/8 inoxidable
 Sputacchiera, 18/8 inossidabile

Verschiedene Behälter
Different containers

Boîtes diverses
Contenedores varios
Vassoi diversi



0.20 l	90 mm Ø x 90 mm	388-136-020
0.50 l	115 mm Ø x 115 mm	388-136-050
1.00 l	140 mm Ø x 160 mm	388-136-100
1.50 l	155 mm Ø x 160 mm	388-136-150
2.00 l	160 mm Ø x 185 mm	388-136-200

Messbecher, graduert, matt, 18/8 rostfrei

Jugs, graduated, tarnished, 18/8 stainless steel
Gobelets gradué, dépoli, 18/8 inoxydable
Vasos medianos, mate, 18/8 inoxidable
Bicchieri graduati, 18/8 inossidabile



456-698-230	456-698-310
-------------	-------------

für Kinder
for children
pour enfants
para niños
per bambini

für Erwachsene
for adults
pour adultes
para adultos
per adulti

Stechbecken, matt, 18/8 rostfrei

Bedpans, tarnished, 18/8 stainless steel
Bassins hygiénique, dépoli, 18/8 inoxydable
Basinas, mate, 18/8 inoxidable
Padelle, 18/8 inossidabile

Verschiedenes

Miscellaneous



20

Instrumententabletts, Instrumentenkästen

Instrument trays, Instrument boxes

Plateaux pour instruments, boîtes pour instruments

Bandejas para instrumentos, cajas para instrumentos

Baccinelle per strumenti, scatole per strumenti



200 mm x 150 mm x 20 mm	73-150-001
240 mm x 160 mm x 30 mm	73-150-002
300 mm x 220 mm x 30 mm	73-150-003
350 mm x 250 mm x 40 mm	73-150-004
400 mm x 300 mm x 40 mm	73-150-005

Sprizentabletts, 18/8 rostfrei

Trays for syringes, 18/8 stainless steel
Tableaux pour seringues, 18/8 inoxydable
Bandejas para jeringas, 18/8 inoxidable
Baccinelle per siringhe, 18/8 inossidabile



165 mm x 90 mm x 35 mm	73-300-001
200 mm x 100 mm x 50 mm	73-300-002
220 mm x 150 mm x 50 mm	73-300-003
260 mm x 150 mm x 50 mm	73-300-004
305 mm x 205 mm x 50 mm	73-300-005

Sprizentabletts, 18/8 rostfrei

Trays for syringes, 18/8 stainless steel
Tableaux pour seringues, 18/8 inoxydable
Bandejas para jeringas, 18/8 inoxidable
Baccinelle per siringhe, 18/8 inossidabile

Sterilisiertrommeln
Sterilizing drums

Tambours à stérilisation
Tambores para esterilización
Tambori per sterilizzazione



SCHIMMELBUSCH

106 mm Ø x 116 mm	388-148-120
188 mm Ø x 183 mm	388-155-190
239 mm Ø x 159 mm	388-160-160
239 mm Ø x 238 mm	388-160-240
285 mm Ø x 159 mm	388-165-160
334 mm Ø x 236 mm	388-170-240
384 mm Ø x 286 mm	388-175-290

Sterilisiertrommeln, Maße inklusive überstehender Teile, 18/8 rostfrei
Sterilizing drums, overall measurements, 18/8 stainless steel
Tambours à stérilisation, dimensions totales, 18/8 inoxydable
Cilindros para esterilización, medidas totales, 18/8 inoxidable
Scatole per sterilizzazione, 18/8 inossidabile



KONRICH

106 mm Ø x 118 mm	73-410-002
138 mm Ø x 105 mm	73-410-003
156 mm Ø x 146 mm	388-185-160
188 mm Ø x 140 mm	388-185-190
239 mm Ø x 160 mm	388-190-160
239 mm Ø x 240 mm	388-190-240
285 mm Ø x 160 mm	388-195-160
285 mm Ø x 240 mm	388-195-240
334 mm Ø x 238 mm	388-200-240
384 mm Ø x 288 mm	388-205-290

Sterilisiertrommeln, Maße inkl. überstehender Teile, 18/8 rostfrei
Sterilizing drums, overall measurements, 18/8 stainless steel
Tambours à stérilisation, dimensions totales, 18/8 inoxydable
Cilindros para esterilización, medidas totales, 18/8 inoxidable
Scatole per sterilizzazione, 18/8 inossidabile



Sterilisierbehälter

Sterilizing cases

Boîtes de stérilisation

Cajas para esterilización

Scatole per sterilizzazione

402 mm x 158 mm x 112 mm	73-450-010
402 mm x 158 mm x 52 mm	73-450-009
392 mm x 138 mm x 77 mm	73-450-008
392 mm x 138 mm x 32 mm	73-450-007
182 mm x 138 mm x 32 mm	73-450-006
302 mm x 158 mm x 112 mm	73-450-005
302 mm x 158 mm x 52 mm	73-450-004
332 mm x 118 mm x 67 mm	73-450-003
332 mm x 118 mm x 27 mm	73-450-002
162 mm x 118 mm x 27 mm	73-450-001



Behälterunterteil und Deckel sind tiefgezogen. Beide Teile sind gelocht und mit Baumwollfiltern ausgestattet. Zum raschen Filterwechsel wurden jeweils nur zwei Rändelmutter angebracht. Der Deckel ist aus rostfreiem Edelstahl 1.4301 hergestellt. Eine im Deckel integrierte Silikonichtung sorgt für absolute Dichtigkeit. Das Behälterunterteil aus Aluminium ist bronzeeloxiert, kann aber auf Wunsch auch andersfarbig eloxiert werden. Die Schnellspanverschlüsse mit Tragegriff sind plombierbar und ab einer Höhe von 60 mm angebracht.

Both parts are deep-drawn. Both parts are perforated and include cotton filters. Easy handling for changing the filters. The cover is made of stainless steel NO NO NO. 1.4301. A silicone sealing is incorporated in the cover to ensure absolute tightness. The bottom part is made of eloxated aluminium. Colours on request. The locking systems can be sealed and are fixed in a height of 60 mm.

Couvercle et boîtier sont emboutis. Les deux parties sont perforées et contiennent des filtres en coton. Changement rapide des filtres avec deux molettes. Le couvercle est d'acier inox 1.4301. Un joint en silicone dans le couvercle garanti l'étanchéité. Le boîtier est d'aluminium eloxé. Différentes couleurs sur demande. Les fermetures et poignées peuvent être plombées. Elles sont fixées à partir d'une altitude de 60 mm.

Fondo y tapa son ajustables. Ambas partes son perforadas y equipados con filtros de textil. Cambio rápido de los filtros. La tapa es de acero inoxidable 1.4301. Bordes de silicona, incorporadas en la tapa garantizan la hermeticidad de los contenedores. El fondo es de aluminio eloxado. Colores según demanda. Los cierres y los mangos pueden ser cerrados y son montados a partir de una altitud de 60 mm.

Coperchio e contenitore costruiti in un pezzo unico, senza saldature; entrambi sono forati e sono forniti di filtri di cotone. Facilità di sostituzione dei filtri. Il coperchio è fatto di acciaio inox N. 1.4301. Una guarnizione in silicone è incorporata nel coperchio per assicurare una ermeticità assoluta. Il fondo è di alluminio anodizzato. Colori su richiesta. Il sistema di chiusura può essere sigillato ed il fissaggio ha una altezza di 60 mm.

Instrumenten-Kassetten aus Edelstahl Instrument trays made of stainless steel

Contenaires d'instruments en acier inox
Caja para instrumental en acero inox
Scatole per sterilizzazione di acciaio inossidabile

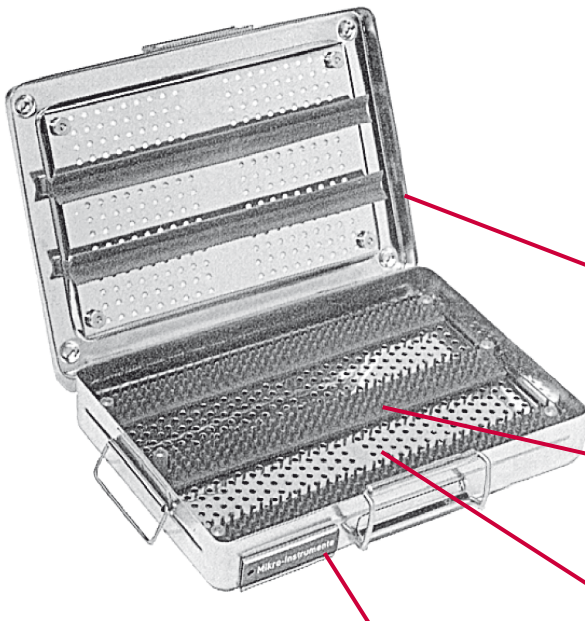

Mit Deckel- und Bodenlochung mit Textil-Langzeitfiltern für Dampfsterilisation
With lid and bottom perforation with textil "Longterm" filters for steam sterilisation
Couvercle et boîtier perforé avec filtre en textile pour stérilisation à vapeur
Con perforación en tapa y fondo, con filtros en tejido para esterilización a vapor
Con filtri tessili, per la sterilizzazione a vapore

Silikon-Andrückleisten zum Fixieren der Instrumente
Silicone protective strips for fixation of instruments
Tapis en silicone pour fixer les instruments
Tiras de silicon para fijar los instrumentos
Righe di silicone per fissare gli strumenti

Silikon-Noppenstreifen zur schonenden Auflage der Instrumente
Silicon strips for a soft and protective storage of the instruments
Tapis en silicone pour la protection des instruments
Matas de silicon para proteger los instrumentos
Stuoie di silicone per proteggere gli strumenti

Kennzeichnungsschilder nach Wahl (Farbe und Text)
Marking plate for selection: colour and description
Plaque d'identification (texte et couleur selon demande)
Placas de identificación a opción (color y texto)
Placche d'identificazione (colore a scelta)

1 herausnehmbare Siebplatte
1 removable tray insert
1 tableau pour sortir
1 cesta
1 cestello

200 x 140 x 55 mm	280 x 195 x 65 mm	265 x 255 x 55 mm	380 x 260 x 65 mm	470 x 250 x 65 mm
73-456-001	73-456-004	73-456-005	73-456-007	73-456-010

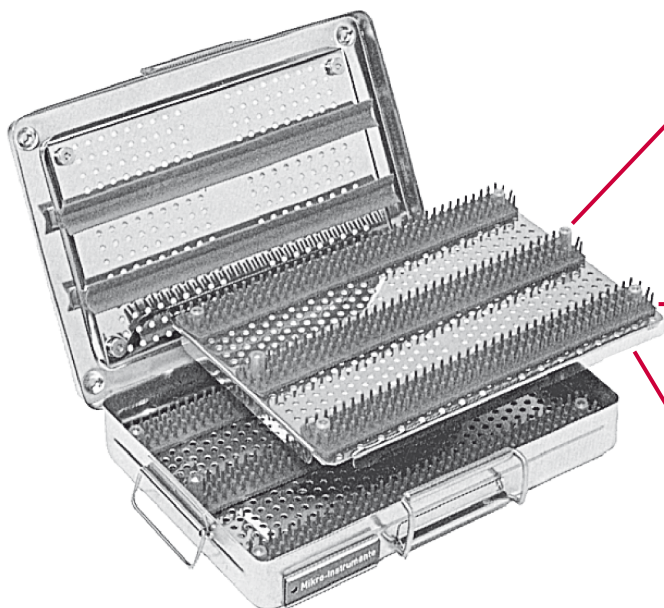

wärmeisolierende Halteknöpfe zum Herausheben
heatisolated handles
pins isolés pour sortir des tableaux
pernos aislados para sacar las placas
maniglia a forma di botone

2 herausnehmbare Siebplatten
2 removable tray inserts
2 tableaux detachables
2 placas para sacar
2 cestelli

Silikon-Andrückleisten an der Unterseite des Siebes
Silicon protective strips at the lower side of the tray
Tapis de silicone à la partie inférieure des tableaux
Tiras de silicon a bajo de las placas
Righe di silicone

200 x 140 x 55 mm	280 x 195 x 65 mm	265 x 255 x 55 mm	380 x 260 x 55 mm	470 x 250 x 65 mm
73-452-001	73-452-004	73-452-005	73-452-007	73-452-010



Sterilisierbehälter
Sterilizing cases

Boîtes de stérilisation
Cajas para esterilización
Scatole per sterilizzazione



Bitte fordern Sie unseren Spezialkatalog an.
Please ask for our special catalogue.

Veillez demander pour notre catalogue spécial.
Por favor preguntar por el catálogo especial.
Per favore domandate per il nostro catalogo speciale

Pflegemittel – Spezial Ölspray
Detergent – special oil-spray

Détergent – spray huileux
Detergente – spray de aceite

Detergente – olio speciale spray



79-130-040

Indikation und Anwendung:

- ▲ Zum Schmieren gereinigter chirurgischer Instrumente, auch solcher mit Gelenken
- ▲ Das Einsprühen erfolgt nach der Reinigung und vor der Sterilisation der Instrumente mit Dampf, Gas oder Heißluft (bis 200°C)
- ▲ Eignet sich zur Verwendung in der Zentralsterilisation ebenso wie in kleineren Sterilisations-Einheiten, sowie in der ärztlichen, zahnärztlichen und der tierärztlichen Praxis

Technische Daten – Bestellinformationen

Merkmale:

- ▲ Hauptbestandteil: flüssiges Paraffin
- ▲ Enthält keine Silikonanteile
- ▲ Sprühkopf mit spezieller Sprühkanüle

Vorteile:

- ▲ Verringert die Anfälligkeit für Fleckenbildung und Verfärbung
- ▲ Vermindert Eiweiß- und Mineralablagerungen
- ▲ Ein mikrofeiner Ölfilm ermöglicht ein leichtes und schnelles Reinigen der Instrumente
- ▲ Durch die hohe Kriechfähigkeit gelangt das Paraffinöl selbst in feinste Gelenke und Schlüsse
- ▲ Verlängert die Lebensdauer der Instrumente und reduziert die Notwendigkeit von Reparaturen
- ▲ Verlängert die Schneidfähigkeit von Scheren
- ▲ Rostvorbeugend
- ▲ Physiologisch unbedenklich
- ▲ Vermeidet Krustenbildung auf den Instrumentenoberflächen
- ▲ Sprühstrahl kann gezielt in Gelenke und Steckverschlüsse gerichtet werden
- ▲ Sparsam im Gebrauch

Indication and application:

- ▲ To lubricate cleaned surgical instruments, also with boxlocks or pivot joints
- ▲ The spray is applied on instruments after cleaning and drying but prior to sterilization by steam, gas or hot air (up to 200°C)
- ▲ May be used in central sterilization departments, as well as in smaller sterilization units, or in medical, dental and veterinary surgeries

Technical data – order information

Feature:

- ▲ Lubricant: Paraffinum liquidum
- ▲ Free of silicone components
- ▲ Nozzle head with special spray cannula

Advantages:

- ▲ Reduces staining and spotting
- ▲ Less protein- and mineral deposits on the instrument surface
- ▲ Facilitates quick and easy instrument cleaning
- ▲ Paraffin oil reaches even the smallest boxlocks or pivot joints
- ▲ Prolongs the shelf life of surgical instruments and helps to reduce repairs
- ▲ Prolongs the sharpness of scissors and blades
- ▲ Rust preventive
- ▲ Preventive lubrication
- ▲ Physiologically harmless
- ▲ Avoids incrustation on instrument surfaces
- ▲ Allows precise spraying directly into pivot joints and boxlocks
- ▲ Economical



Pflegemittel – Spezial Ölspray **Detergent – special oil-spray**

Détergent – spray huileux
Detergente – spray de aceite
Detergente – olio speciale spray

79-130-040

Indication / Application:

- ▲ Pour lubrifier des instruments nettoyés avec ou sans joints
- ▲ L'huile est appliqué après le nettoyage et séchage, mais avant la stérilisation à vapeur, gas ou air chaude (max. 200°C)
- ▲ Pour l'utilisation dans la stérilisation centrale ainsi que dans des cabinets privés de dentaire et vétérinaire

Dates techniques / Informations

Caractéristiques:

- ▲ Composants principal : paraffine liquide
- ▲ Ne contient pas du silicone
- ▲ Canule fine pour application directe

Avantages:

- ▲ Réduit la réceptivité du matériel pour des taches et de décoloration
- ▲ Réduit des dépôts des protides et des minéraux
- ▲ Facilite la nettoyage simple et rapide des instruments
- ▲ Prolongue la durée de vie des instruments et réduit la nécessité des réparations
- ▲ Les joints des instruments restent mobiles
- ▲ Préviennent à la corrosion
- ▲ Sans inconvénient physiologique
- ▲ Evite des incrustations sur les instruments
- ▲ Permet une application précise dans les articulations et joints
- ▲ Economique

79-130-040

Indicazioni / Applicazioni:

- ▲ Per lubrificare strumenti puliti, anche con fermi o giunti
- ▲ Lo spray va applicato sugli strumenti dopo la pulizia e l'asciugatura ma prima della sterilizzazione a vapore, gas o aria calda (oltre a 200°C)
- ▲ Può essere utilizzato nelle grandi centrali di sterilizzazione così come nelle piccole unità, o in dipartimenti medici, dentistici e veterinari

Caratteristiche Tecniche / Informazioni per l'acquisto

Caratteristiche:

- ▲ Lubrificante: Paraffina liquida
- ▲ Senza componenti in silicone
- ▲ Tappo con speciale cannula spray

Indicación / Aplicación:

- ▲ Para lubricar instrumental lavado, con articulaciones y cavidades
- ▲ El spray se aplica después de la limpieza y secado pero antes de la esterilización a vapor, gas o aire caliente (hasta 200°C)
- ▲ Recomendado para utilizarse en centrales de esterilización, como también en pequeños lugares de esterilización, en consultorios médicos, dentales y veterinarios

Datos técnicos / Información para pedido

Propiedades:

- ▲ Componentes: parafina líquida
- ▲ Libre de componentes de silicona
- ▲ Cabezal del spray con cánula especial

Ventajas:

- ▲ Reduce la formación de manchas y decoloraciones
- ▲ Reduce los depósitos de minerales y proteínas en la superficie del instrumental
- ▲ Facilita la limpieza rápida y fácil del instrumento
- ▲ El aceite de parafina alcanza llegar hasta en las mas pequeñas cavidades y articulaciones
- ▲ Prolonga la vida útil del instrumento y reduce la necesidad de reparaciones
- ▲ Prolonga la vida filo de las tijeras
- ▲ Preventivo a la corrosión
- ▲ Lubricación preventiva
- ▲ Fisiológicamente inofensivo
- ▲ Evita incrustaciones en la superficie del instrumental
- ▲ Permite una aplicación precisa en las articulaciones y en cavidades
- ▲ Económico

Vantaggi:

- ▲ Riduce le macchie e gli scolorimenti
- ▲ Minori depositi proteici e minerali sulla superficie degli strumenti
- ▲ Garantisce una veloce e facile pulizia degli strumenti
- ▲ L'olio di paraffina raggiunge anche i più piccoli fermi o giunti
- ▲ Prolunga la vita degli strumenti chirurgici ed aiuta a ridurre le riparazioni
- ▲ Prolunga il filo di forbici e lame
- ▲ Previene la ruggine
- ▲ Lubrificazione preventiva
- ▲ Innocuo fisiologicamente
- ▲ Evita le incrostazioni sulla superficie degli strumenti
- ▲ Garantisce una irrorazione precisa in giunti e fermi
- ▲ Economico

Pflegemittel – Instrumentenmilch
Detergent – instrument milk

Détergent – lait d'instruments
Detergente – leche para instrumental
Detergente – latte per strumenti



5 l

79-120-500

Indikation und Anwendung:

- ▲ Zur täglichen Pflege von Metall-Instrumenten in Reinigungsmaschinen oder Instrumentensieben
- ▲ Zum Schutz der Instrumente vor Rost und Korrosion – kein Reinigungs- oder Desinfektionsmittel
- ▲ Unentbehrlich nach Ultraschall-Reinigungsverfahren, da die gleichzeitig entfernten Schmiermittel ersetzt werden müssen
- ▲ Eignet sich zur Verwendung in der Zentralsterilisation, ebenso wie in kleinen Sterilisations-Einheiten, sowie in der ärztlichen, zahnärztlichen und der tierärztlichen Praxis
- ▲ Das Konzentrat wird mit handwarmem Wasser im Verhältnis 1:30 verdünnt
- ▲ Die gewaschenen Instrumente werden in die verdünnte Instrumentenmilch getaucht, abgetropft und anschließend sterilisiert

Technische Daten – Bestellinformationen

Merkmale:

- ▲ Hauptbestandteil: flüssiges Paraffin
- ▲ Enthält keine Silikonanteile

Vorteile:

- ▲ Verringert die Anfälligkeit für Fleckenbildung und Verfärbung
- ▲ Vermindert Eiweiß- und Mineralablagerungen
- ▲ Ein mikrofeiner Ölfilm ermöglicht ein leichtes und schnelles Reinigen der Instrumente
- ▲ Gelenke und Schlüsse der Instrumente bleiben frei beweglich
- ▲ Verlängert die Lebensdauer der Instrumente und reduziert die Notwendigkeit von Reparaturen
- ▲ Keine Nachbehandlung (wie Trocknen, Polieren oder Schmieren) erforderlich
- ▲ Rostvorbeugend
- ▲ Physiologisch unbedenklich
- ▲ Vermeidet Krustenbildung auf den Instrumentenoberflächen
- ▲ Wirtschaftlich

Indication and application:

- ▲ For daily care of metal instruments in trays and automatic washers
- ▲ No disinfectant or detergent, but for care, lubrication and rust prevention
- ▲ Indispensable after ultrasonic cleaning, as removed lubricants have to be compensated
- ▲ May be used in central sterilization departments, as well as in smaller sterilization units, or in medical, dental and veterinary surgeries
- ▲ The concentrate is diluted with lukewarm water (1:30) and filled into an instrument tray or automatic washer
- ▲ The cleaned and rinsed instruments are immersed in the diluted instrument milk, dripped off and then sterilized

Technical data – order information

Features:

- ▲ Lubricant: Paraffinum liquidum
- ▲ Free of silicone components

Advantage:

- ▲ Reduces staining and spotting
- ▲ Less protein- and mineral deposits on the instrument surface
- ▲ Facilitates quick and easy instrument cleaning
- ▲ Keeps boxlocks and other pivot joints freely moving
- ▲ Prolongs the shelf life of surgical instruments and helps to reduce repairs
- ▲ No follow-up treatment necessary (like drying, polishing or oiling)
- ▲ Rust preventive
- ▲ Physiologically harmless
- ▲ Avoids incrustation
- ▲ Economical



Pflegemittel – Instrumentenmilch

Detergent – instrument milk

Détergent – lait d'instruments

Detergente – leche para instrumental

Detergente – latte per strumenti

5 l

79-120-500

Indication / Application:

- ▲ Pour le soin quotidien des instruments en acier, dans des machines à laver ou des contenaires
- ▲ Indispensable après le nettoyage à ultrason pour remplacer des lubrifiants
- ▲ Pour l'utilisation dans la stérilisation centrale ainsi que dans des cabinets privés de dentaire et vétérinaire
- ▲ Le lait d'instrument est concentré et doit être dosé 1 : 30 avec de l'eau tempérée
- ▲ Les instruments lavés sont immergés dans le lait d'instruments dilué, égouttés et après stérilisés

Dates techniques / Informations

Caractéristiques:

- ▲ Composants principaux: paraffine liquide
- ▲ Ne contient pas du silicone

Avantages:

- ▲ Réduit la réceptivité du matériel pour des taches et de décoloration
- ▲ Réduit des dépôts des protides et des minéraux
- ▲ Facilite la nettoyage simple et rapide des instruments
- ▲ Prolonge la durée de vie des instruments et réduit la nécessité des réparations
- ▲ Les joints des instruments restent mobiles
- ▲ Séchage et polissage ne sont pas nécessaires
- ▲ Préviend à la corrosion
- ▲ Sans inconvénient physiologique
- ▲ Évite des incrustations sur les instruments
- ▲ Economique

5 l

79-120-500

Indicazioni / Applicazioni:

- ▲ Per la cura giornaliera degli strumenti in metallo nei cestelli e lavatrici automatiche
- ▲ Non è un disinfettante o un detergente, ma per la manutenzione, lubrificazione e prevenzione della ruggine
- ▲ Indispensabile dopo pulizia ultrasonica, poiché questa rimuove il lubrificante che deve essere reintegrato
- ▲ Può essere utilizzato nelle grandi centrali di sterilizzazione così come nelle piccole unità, o in dipartimenti medici, dentistici e veterinari
- ▲ Il concentrato va diluito in acqua lukewarm (1:30) e versato in un contenitore per strumenti o in una lavatrice automatica
- ▲ Gli strumenti puliti e risciacquati vanno immersi nel latte diluito, lasciati sgocciolare e dopo sterilizzati

Indicación / Aplicación:

- ▲ Para el cuidado diario de instrumental metálico en bandejas o máquinas de limpieza
- ▲ No es un desinfectante o detergente, es para el cuidado, la lubricación y la prevención a la corrosión
- ▲ Indispensable después de la limpieza con ultrasonido, lubricante eliminado debe ser compensado
- ▲ Recomendado para utilizar en centrales de esterilización, como también en pequeños lugares de esterilización, en consultorios médicos, dentales y veterinarios
- ▲ El concentrado tiene que ser diluido con agua tibia (1:30) y rellenado en un recipiente para instrumental o lavadora automática
- ▲ Los instrumentos lavados se inmerjen en el la leche de instrumental diluido, escurridos y a continuación esterilizados

Datos técnicos / Información para pedido

Propiedades:

- ▲ Componentes: parafina líquida
- ▲ Libre de componentes de silicona

Ventajas:

- ▲ Reduce la formación de manchas y decoloraciones
- ▲ Reduce los depósitos de minerales y proteínas en la superficie del instrumental
- ▲ Facilita la limpieza rápida y fácil del instrumento
- ▲ Mantiene las articulaciones móviles
- ▲ Prolonga la vida útil del instrumento y reduce la necesidad de reparaciones
- ▲ No requiere tratamientos secundarios (como secado, pulimento o lubricado)
- ▲ Preventivo a la corrosión
- ▲ Fisiológicamente inofensivo
- ▲ Evita incrustaciones
- ▲ Económico

Caratteristiche Tecniche / Informazioni per l'acquisto

Caratteristiche:

- ▲ Lubrificante: Paraffina liquida
- ▲ Senza componenti in silicone

Vantaggi:

- ▲ Riduce le macchie e gli scolorimenti
- ▲ Minori depositi proteici e minerali sulla superficie degli strumenti
- ▲ Garantisce una veloce e facile pulizia degli strumenti
- ▲ Mantiene liberi di muoversi giunti e fermi
- ▲ Prolunga la vita degli strumenti chirurgici ed aiuta a ridurre le riparazioni
- ▲ Non necessita di ulteriore trattamento (come asciugatura, lucidatura od oliatura)
- ▲ Previene la ruggine
- ▲ Inncuo fisiologicamente
- ▲ Evita le incrostazioni
- ▲ Economico

Endoskopie
Endoscopy

Endoscopie
Endoscopio
Endoscopia

A-line[®]
endoscopy



Bitte fordern Sie unseren Spezialkatalog an.
Please ask for our special catalogue.

Veillez demander pour notre catalogue spécial.

Por favor preguntar por el catálogo especial.

Per favore domandate per il nostro catalogo speciale