

16

Magen, Darm, Rektum

Stomach, Intestines, Rectum

Estomac, Intestins, Rectum

Estómago, Intestinos, Recto

Stomaco, Intestini, Retto



Magen, Darm, Rektum

Stomach, Intestines, Rectum



Gewebe- und Darmfazzangen

Tissue and intestinal holding forceps

Pinces intestinales et de tissue
Pinzas para tejidos y intestinos
Pinze per tessuti ed intestinali



ALLIS

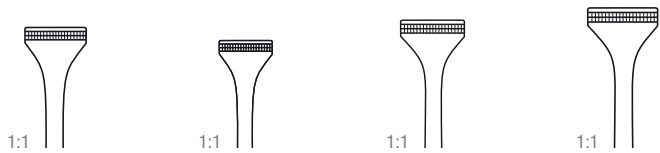

			Atrauma	Atrauma	Atrauma	Atrauma
155 mm – 6"	13-810-155	13-812-155	364-120-160			
190 mm – 7½"		13-812-190				
200 mm – 8"				364-120-200		
230 mm – 9"		13-812-230				
250 mm – 9¾"					364-120-250	
300 mm – 12"						364-120-300

Zähne
Teeth
Dents
Dientes
Denti

4 x 5

5 x 6



1:2

ALLIS-BABY

140 mm – 5½"	364-098-140
--------------	-------------

Zähne
Teeth
Dents
Dientes
Denti

4 x 5



1:2

ALLIS-ADAIR

155 mm – 6"	364-126-150
-------------	-------------

Zähne
Teeth
Dents
Dientes
Denti

10 x 11



1:3

THOMS-ALLIS

200 mm – 8"	13-820-200
-------------	------------

Zähne
Teeth
Dents
Dientes
Denti

6 x 7

Gewebe- und Darmfazzangen

Tissue and intestinal holding forceps

Pinces intestinales et de tissue

Pinzas para tejidos y intestinos

Pinze per tessuti ed intestinali



BOYS-ALLIS

1:2

150 mm – 6"	364-144-150
-------------	-------------

Zähne
Teeth
Dents
Dientes
Denti

5 x 6



JUDD-ALLIS

150 mm – 6"	13-816-150
190 mm – 7½"	13-816-190

Zähne
Teeth
Dents
Dientes
Denti

3 x 4

Magen, Darm, Rektum

Stomach, Intestines, Rectum



Gewebe- und Darmfazzangen

Tissue and intestinal holding forceps

Pinces intestinales et de tissue
Pinzas para tejidos y intestinos
Pinze per tessuti ed intestinali



1:2
LITTLEWOOD

185 mm – 7 ¼" 13-828-185

Zähne
 Teeth
 Dents
 Dientes
 Denti

2 x 3



1:3
LOCKWOOD

200 mm – 8" 430-166-200



1:2
WILLIAMS

160 mm – 6 ¼" 364-176-160



BABCOCK

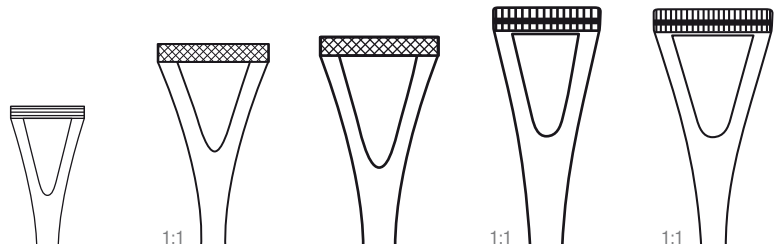

		almedur	almedur	Atrauma	Atrauma
160 mm – 6 ¼"	13-842-160	364-160-160		364-164-160	
180 mm – 7"	13-842-180		364-160-180		
200 mm – 8"	13-842-195		364-160-200		364-164-200
240 mm – 9 ½"	13-842-240				



Gewebe- und Darmfazzangen
Tissue and intestinal holding forceps

Pinces intestinales et de tissue
Pinzas para tejidos y intestinos
Pinze per tessuti ed intestinali

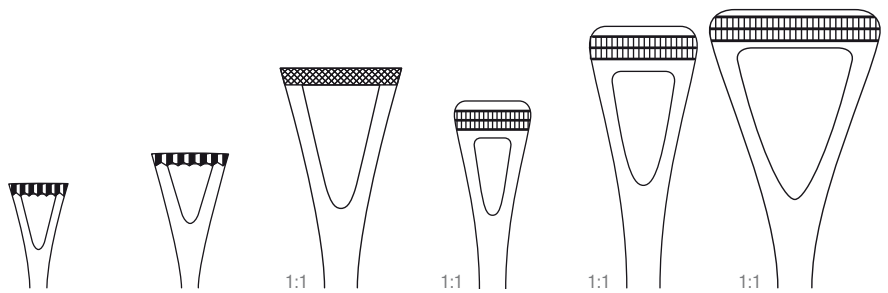

DUVAL

		almedur		Atrauma	Atrauma	Atrauma
180 mm – 7"	364-166-180			430-536-180		
200 mm – 8"	13-852-014	13-852-028	364-170-200		430-536-200	
230 mm – 9"		364-168-230				430-536-230



Magen, Darm, Rektum

Stomach, Intestines, Rectum



Darm- und Magenklappen

Intestinal and stomach clamps

Pinces-clamps pour l'intestin et l'estomac

Pinzas-clamps para el intestino y el estómago

Pinze per intestino e stomaco



1:2

BABY-KOCHER



1:1

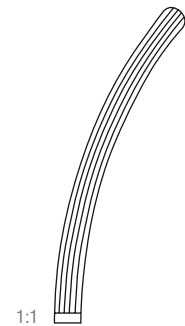

1:1

130 mm – 5"	13-878-130	13-879-130
-------------	------------	------------

Darmklemme für Kinder, sehr elastisch

Intestinal clamp for children, very elastic blades

Pince intestinal pour enfants, très élastique

Pinza intestinal para niños, muy elástica

Pinza intestinale per bambini, molto elastica



1:2

ALLEN



1:1

155 mm – 6"	430-394-160
200 mm – 8"	430-394-200

Zähne
Teeth
Dents
Dientes
Denti

1 x 2

Darmklemme für Kinder

Intestinal clamp for children

Pince intestinal pour enfants

Pinza intestinal para niños

Pinza intestinale per bambini

Darm- und Magenklammern

Intestinal and stomach clamps

Pinces-clamps pour l'intestin et l'estomac

Pinzas-clamps para el intestino y el estómago

Pinze per intestino e stomaco



1:2
**BABY-
DOYEN**



1:1

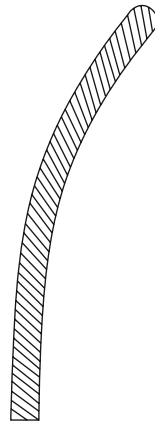

1:1

180 mm – 7"	13-870-180	13-871-180
210 mm – 8 ¼"	13-870-210	13-871-210

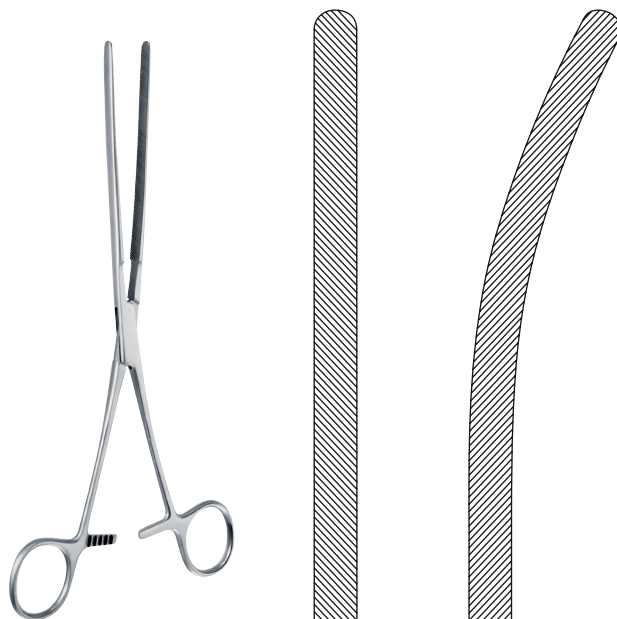

1:3
DOYEN



1:1

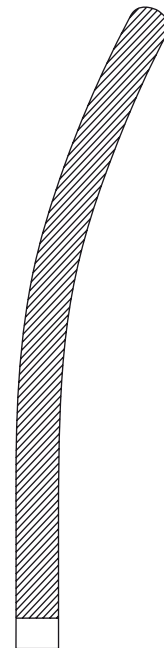

1:1

230 mm – 9"	13-872-230	13-873-230
-------------	------------	------------

Magen, Darm, Rektum

Stomach, Intestines, Rectum



Darm- und Magenklammen

Intestinal and stomach clamps

Pinces-clamps pour l'intestin et l'estomac

Pinzas-clamps para el intestino y el estómago

Pinze per intestino e stomaco

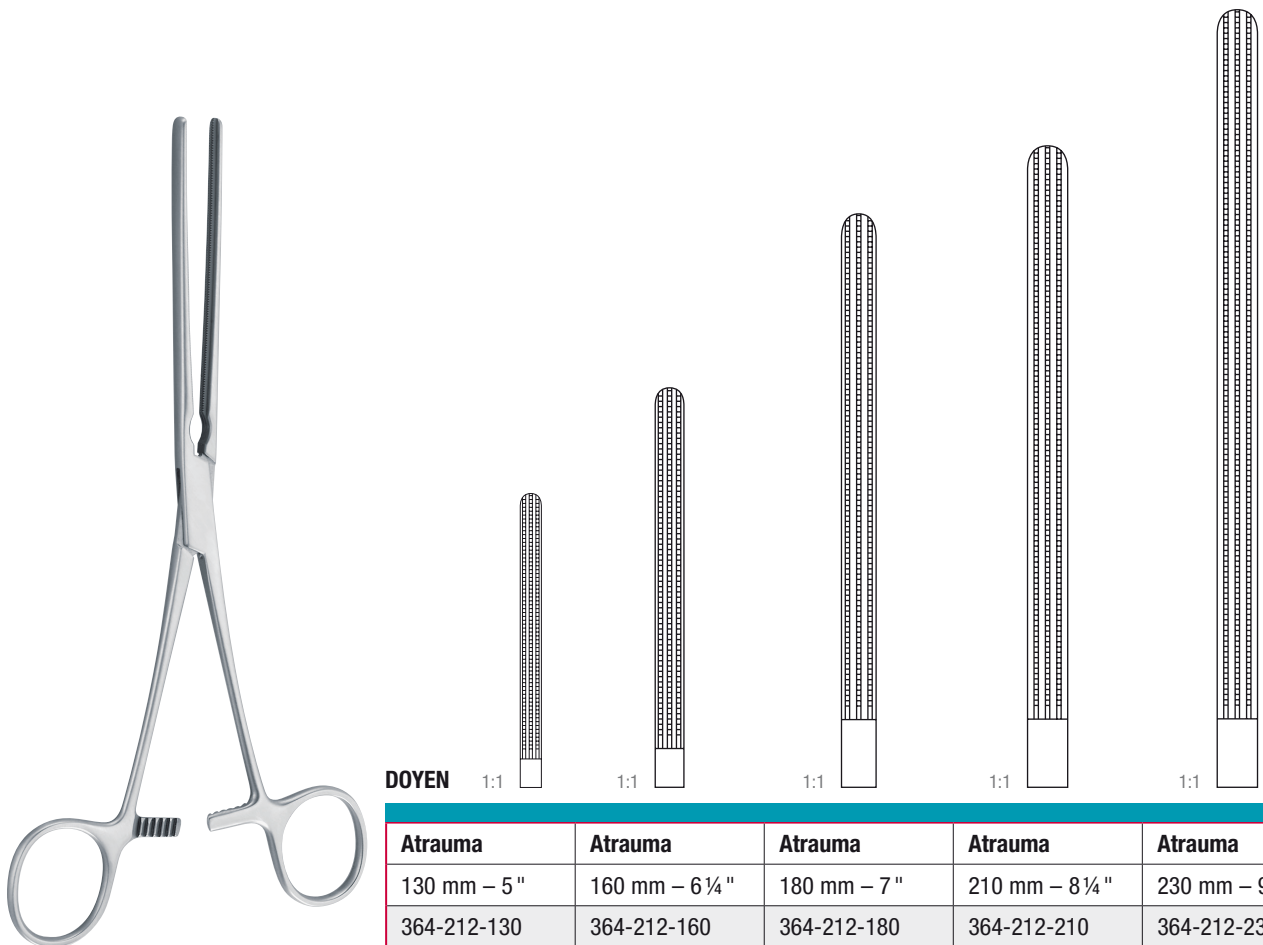

DOYEN

1:1

1:1

1:1

1:1

1:1

Atrauma	Atrauma	Atrauma	Atrauma	Atrauma
130 mm – 5"	160 mm – 6 ¼"	180 mm – 7"	210 mm – 8 ¼"	230 mm – 9"
364-212-130	364-212-160	364-212-180	364-212-210	364-212-230

Darm- und Magenklammern

Intestinal and stomach clamps

Pinces-clamps pour l'intestin et l'estomac

Pinzas-clamps para el intestino y el estómago

Pinze per intestino e stomaco

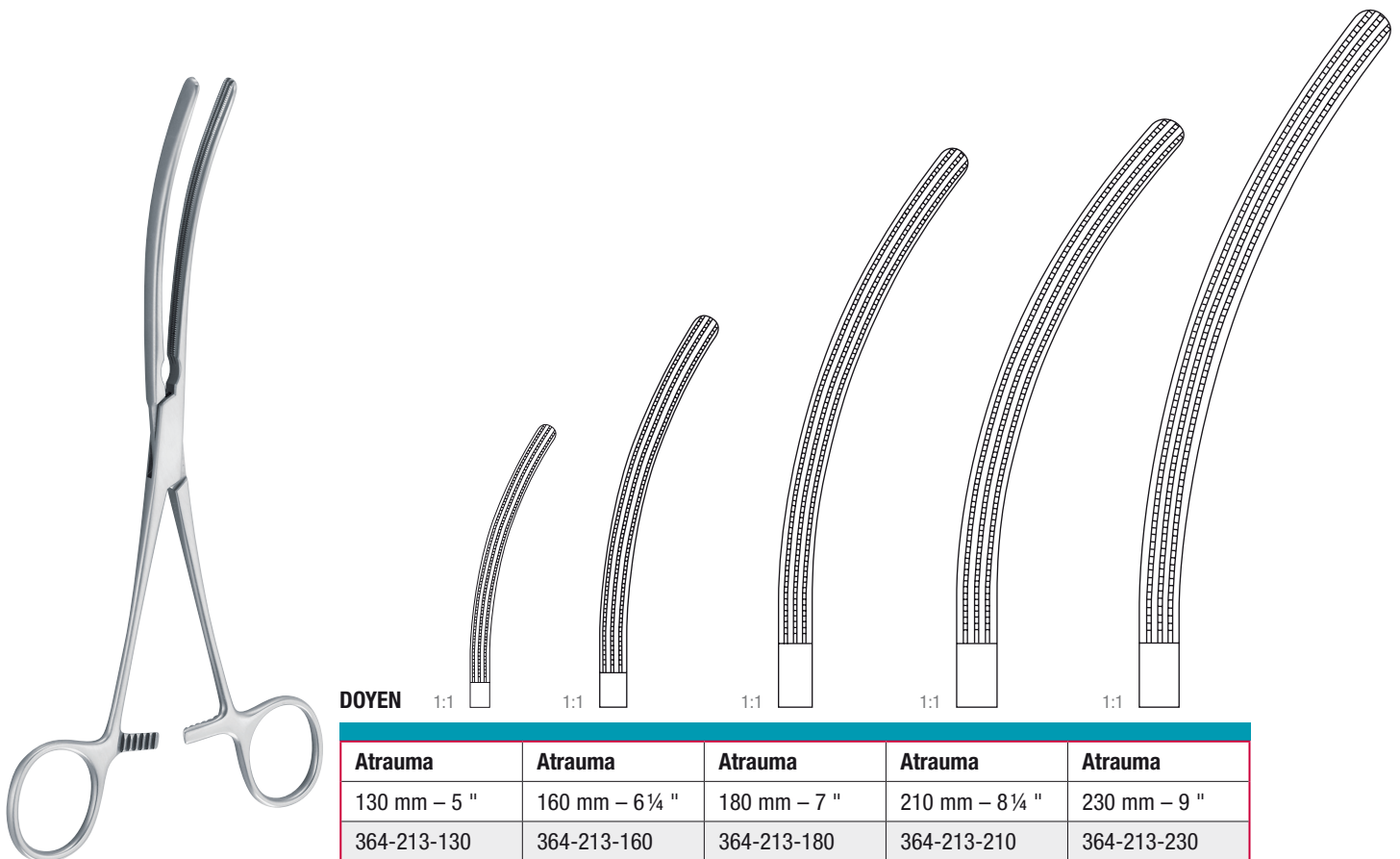

DOYEN

1:1

1:1

1:1

1:1

1:1

Atrauma	Atrauma	Atrauma	Atrauma	Atrauma
130 mm – 5 "	160 mm – 6 ¼ "	180 mm – 7 "	210 mm – 8 ¼ "	230 mm – 9 "
364-213-130	364-213-160	364-213-180	364-213-210	364-213-230

Magen, Darm, Rektum

Stomach, Intestines, Rectum



Darm- und Magenklammern

Intestinal and stomach clamps

Pinces-clamps pour l'intestin et l'estomac

Pinzas-clamps para el intestino y el estómago

Pinze per intestino e stomaco

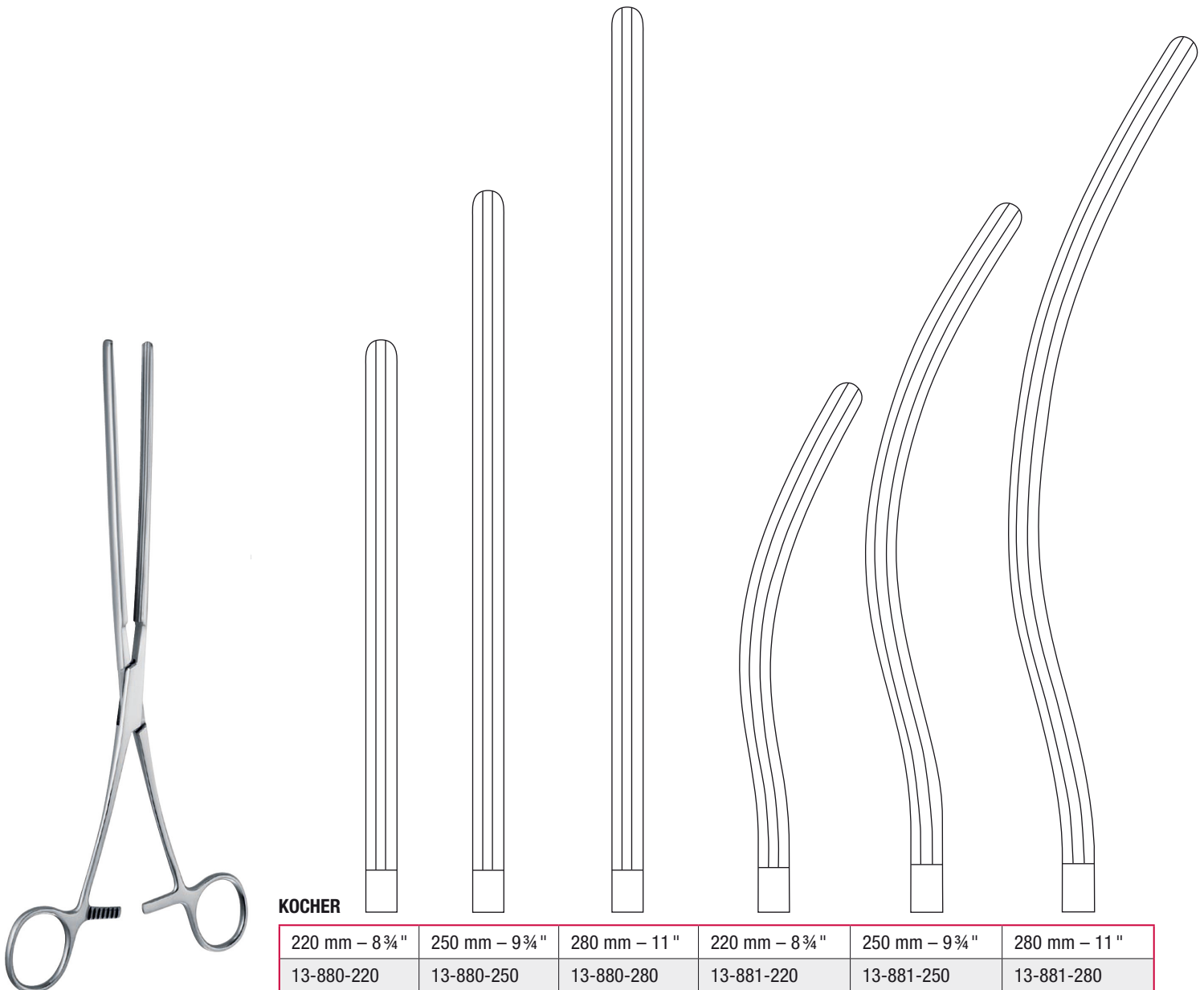

KOCHER

220 mm – 8¾"	250 mm – 9¾"	280 mm – 11"	220 mm – 8¾"	250 mm – 9¾"	280 mm – 11"
13-880-220	13-880-250	13-880-280	13-881-220	13-881-250	13-881-280

Darm- und Magenklappen
Intestinal and stomach clamps

Pinces-clamps pour l'intestin et l'estomac
Pinzas-clamps para el intestino y el estómago
Pinze per intestino e stomaco

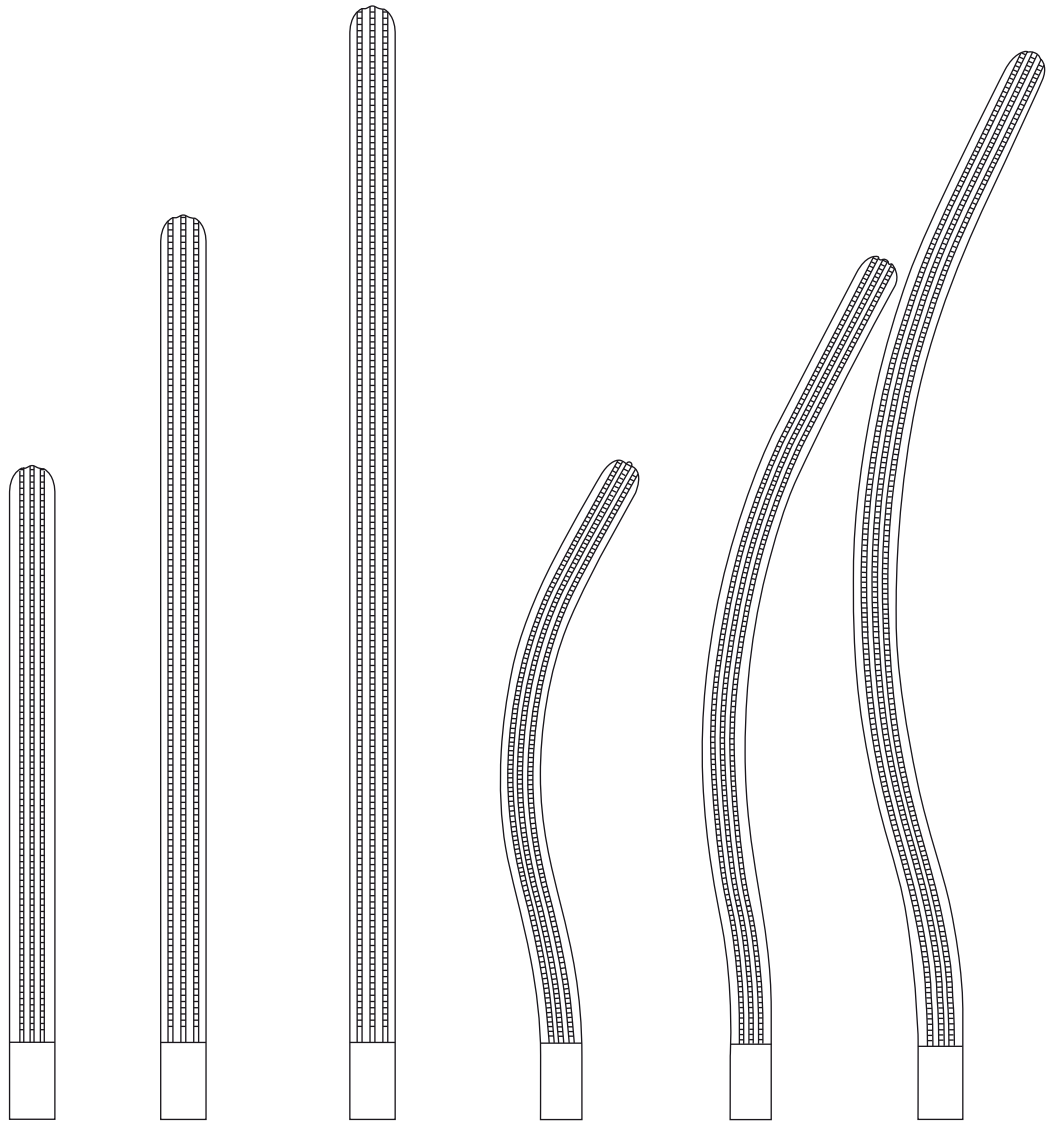

KOCHER

Atrauma	Atrauma	Atrauma	Atrauma	Atrauma	Atrauma
220 mm – 8 ¾ "	250 mm – 9 ¾ "	280 mm – 11 "	220 mm – 8 ¾ "	250 mm – 9 ¾ "	280 mm – 11 "
364-222-220	364-222-250	364-222-280	364-223-220	364-223-250	364-223-280

Magen, Darm, Rektum

Stomach, Intestines, Rectum



Darm- und Magenklappen

Intestinal and stomach clamps

Pinces-clamps pour l'intestin et l'estomac

Pinzas-clamps para el intestino y el estómago

Pinze per intestino e stomaco



1:2
MAYO-ROBSON

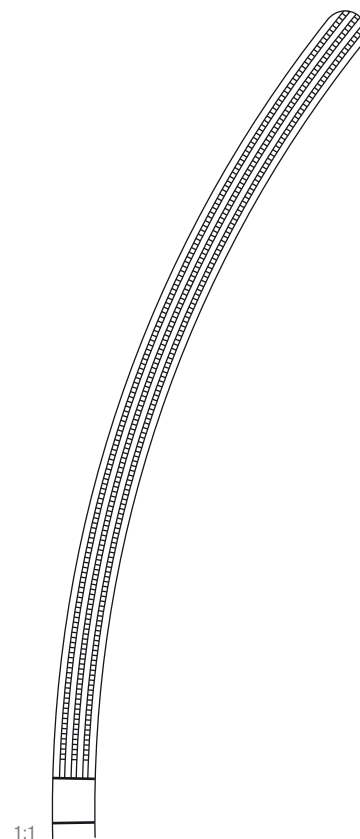
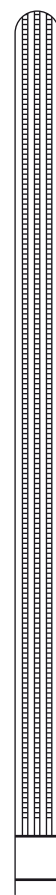
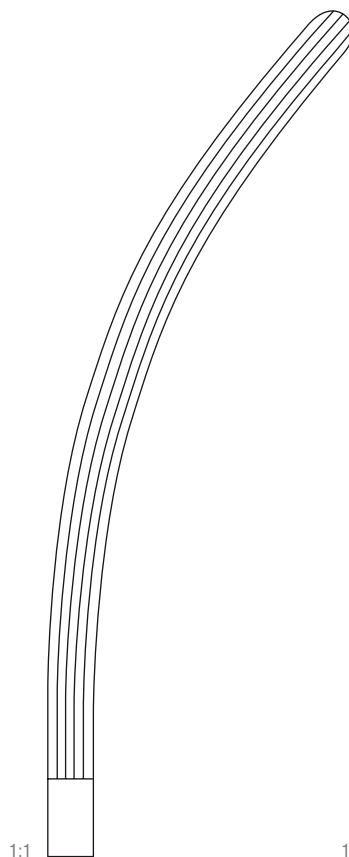

			Atrauma	Atrauma
230 mm – 9"	13-886-230	13-887-230		
250 mm – 9¾"	13-890-250	13-891-250	364-232-250	364-233-250



Darm- und Magenklappen

Intestinal and stomach clamps

Pinces-clamps pour l'intestin et l'estomac

Pinzas-clamps para el intestino y el estómago

Pinze per intestino e stomaco



1:2

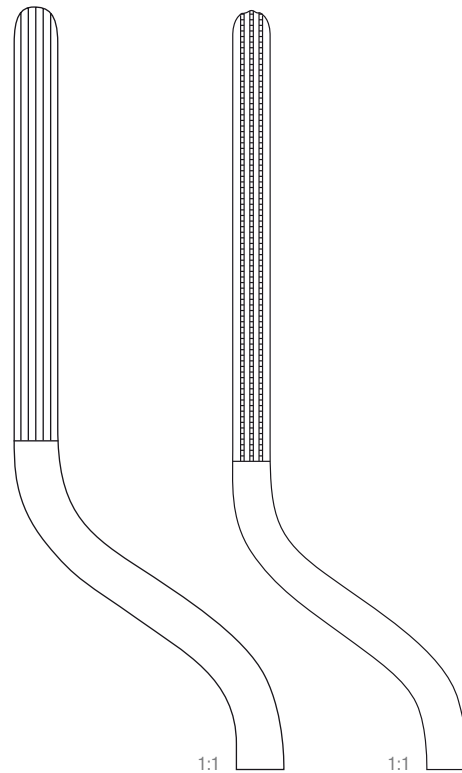

1:1

1:1

BRUNNER

		Atrauma
240 mm – 9 ½"	364-256-240	364-262-240



Magen, Darm, Rektum

Stomach, Intestines, Rectum



Darm- und Magenklappen

Intestinal and stomach clamps

Pinces-clamps pour l'intestin et l'estomac

Pinzas-clamps para el intestino y el estómago

Pinze per intestino e stomaco



1:2

LANE

300 mm – 12"

1:1

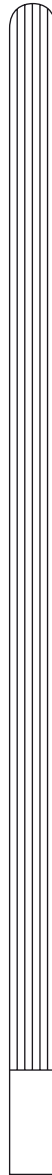

13-780-300

1:1

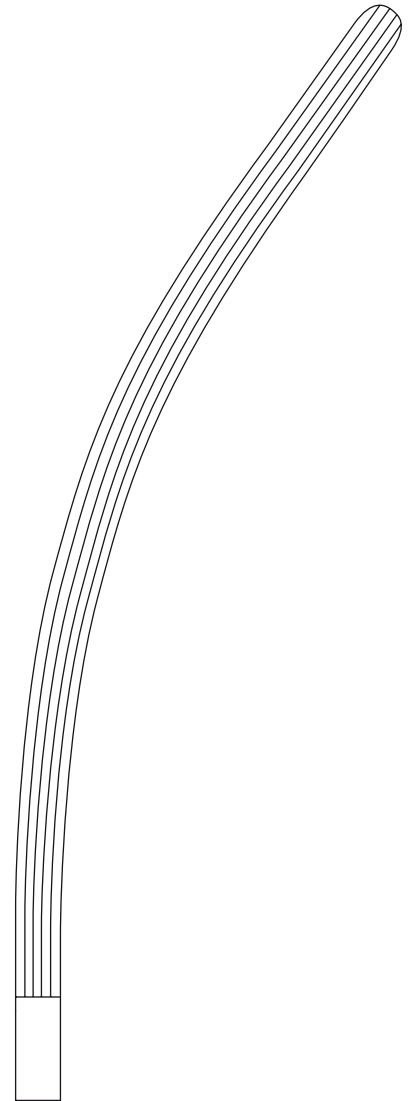

13-781-300

Darm- und Magenklammern

Intestinal and stomach clamps

Pinces-clamps pour l'intestin et l'estomac

Pinzas-clamps para el intestino y el estómago

Pinze per intestino e stomaco



1:2

RESANO

1:1

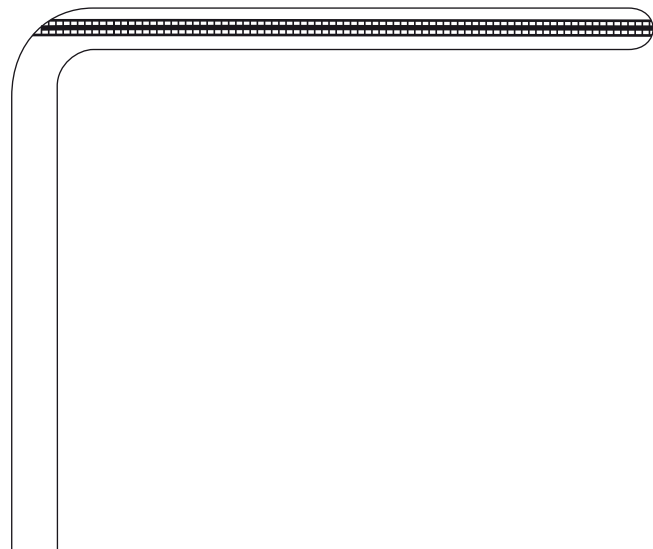

	Atrauma
300 mm – 12"	430-583-300



Rektum-Anastomosenklemmen
Sigmoid anastomosis forceps

Pinces pour anastomoses rectales
Pinzas para anastomosis rectales
Pinze per anastomosi rettali

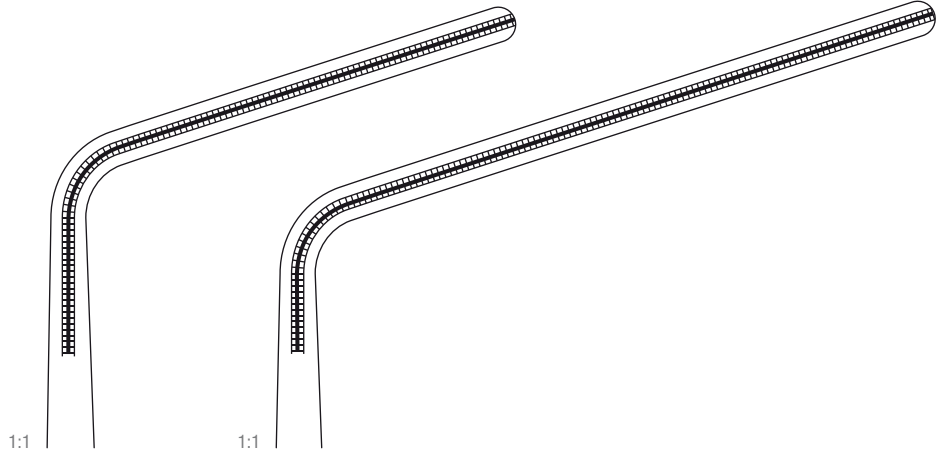

HAYES

Atrauma	Atrauma
260 mm – 10 ¼"	280 mm – 11"
430-577-260	430-577-280

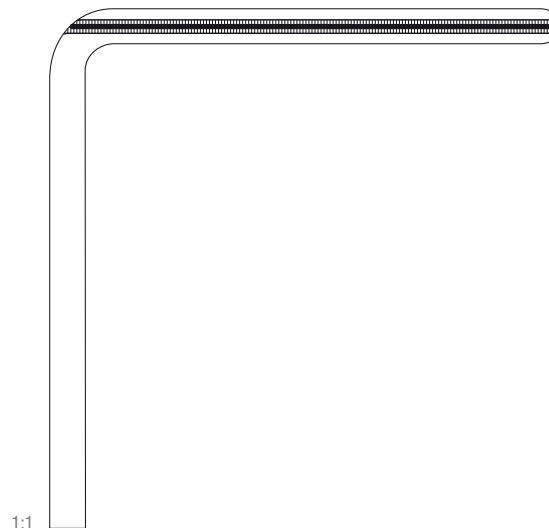

FEHLAND

Atrauma		
230 mm – 9"	364-237-230	364-243-230

1:2

Organfasszangen

Organ grasping forceps

Pinces pour saisir des organes

Pinzas para sacar órganos

Pinze per afferrare organi

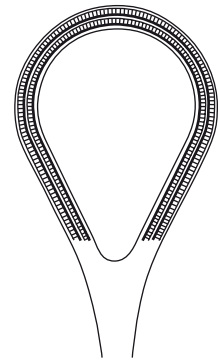
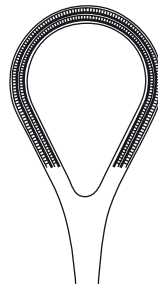

	Atrauma
250 mm – 9 3/4"	413-262-250

	Atrauma
260 mm – 10 1/4"	413-262-260

Organfasszange mittel, 250 mm
Organ grasping forceps medium, 250 mm
Pince medium pour saisir des organes, 250 mm
Pinza mediano para sacar órganos, 250 mm
Pinze per afferrare organi, 250 mm

Organfasszange mittel, 250 mm
Organ grasping forceps medium, 250 mm
Pince medium pour saisir des organes, 250 mm
Pinza mediano para sacar órganos, 250 mm
Pinze per afferrare organi, 250 mm

1:2

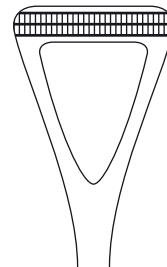
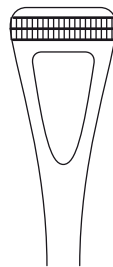

SCHEIBE

Atrauma	Atrauma	Atrauma
180 mm – 7"	200 mm – 8"	230 mm – 9"
430-536-180	430-536-200	430-536-230

schmal
narrow
étroit
estrecho
stretto

mittel
medium
moyen
mediano
medio

breit
wide
large
ancho
largo

1:2

Magen, Darm, Rektum

Stomach, Intestines, Rectum



Darmquetschklemmen
Intestinal and pylorus clamps
Ecraseur pour l'intestin
Pinzas intestinales para piloro
Schiacciatori intestinali



1:2

PAYR-BABY

150 mm – 6"

56-123-150

mit Stift
 with pin
 avec cheville
 con perno
 con perno



1:1



1:2

PAYR

1:1

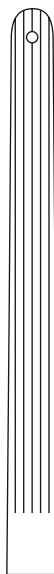

1:1



1:1

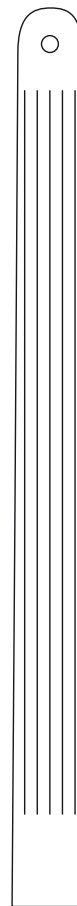

210 mm – 8¼"

290 mm – 11½"

350 mm 13¾"

56-127-210

56-135-290

56-143-350

mit Stift
 with pin
 avec cheville
 con perno
 con perno

Darm- und Anastomosenklemmen

Intestinal and anastomosis clamp forceps

Pinces-clamps intestinales et à anastomose

Pinzas-clamps intestinales y para anastomosis

Pinze intestinali e per anastomosi

**DE MARTEL-
WOLFSON**

1:2



85 mm – 3¼"

56-176-085

**DE MARTEL-
WOLFSON**

1:2



230 mm – 9"

56-176-230

1:2

**DE MARTEL-
WOLFSON**



260 mm – 10¼"

56-174-260

Magen, Darm, Rektum

Stomach, Intestines, Rectum



16

Darm- und Anastomosenklemmen

Intestinal and anastomosis clamp forceps

Pinces-clamps intestinales et à anastomose

Pinzas-clamps intestinales y para anastomosis

Pinze intestinali e per anastomosi

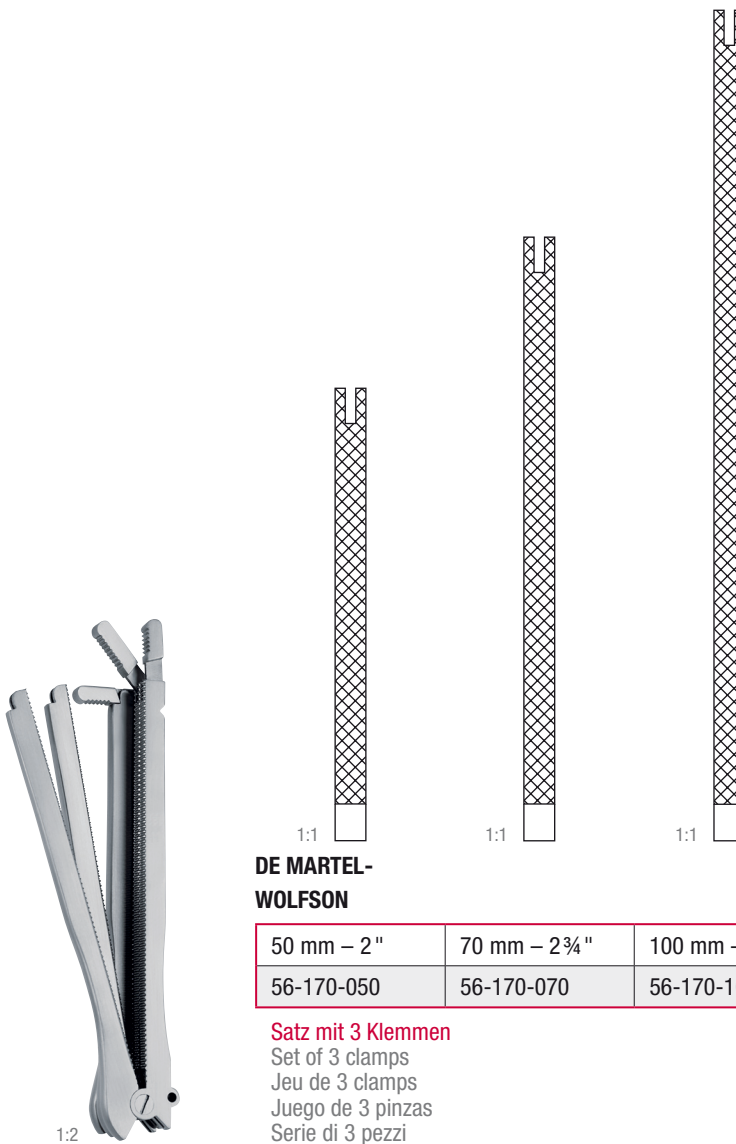

DE MARTEL- WOLFSON

50 mm – 2"	70 mm – 2¾"	100 mm – 4"
56-170-050	56-170-070	56-170-100

Satz mit 3 Klemmen

Set of 3 clamps

Jeu de 3 clamps

Juego de 3 pinzas

Serie di 3 pezzi

Mastdarm-Spekula

Rectal specula

Spéculums pour le rectum

Espéculos rectales

Specoli rettali



SIMS

1:2

1:2

	x = 80 mm x 15 mm	x = 80 mm x 15 mm	x = 80 mm x 15 mm
150 mm – 6"	368-111-150	56-371-150	368-113-150

mit Kaltlichtaufsatz
with F.O. light carrier
avec support lumière froide
con guía de luz fría
con supporto per luce fredda



MATHIEU

1:2

	x = 90 mm
195 mm – 7¾"	56-377-195

Magen, Darm, Rektum

Stomach, Intestines, Rectum



16

Mastdarm-Spekula

Rectal specula

Spéculums pour le rectum

Espéculos rectales

Specoli rettali



PRATT

1:2

	x = 80 mm x 25 mm
205 mm – 8"	368-117-000



CZERNY

1:2

	x = 110 mm x 25 mm
220 mm – 8¾"	368-101-220

Anuskope – Sphinkterskope
Anusscopes – Sphincteroscopes
Anusscopes – Sphinctérosopes
Anoscopios – Esfinteroscopios
Anoscopi – Sfinteroscopi



IVES-FANSLER

1:2

	x = 90 mm	x = 90 mm
22 mm Ø	368-206-220	430-647-650



KELLY

	x = 50 mm
21 mm Ø	56-441-001
27 mm Ø	56-441-002

mit Kaltlichtaufsatz
with F.O. light carrier
avec support lumière froide
con guía de luz fría
con supporto per luce fredda



BENSAUDE

	185 mm – 7 ¼"
	x = 55 mm
19 mm Ø	430-655-010
22 mm Ø	430-655-020

Magen, Darm, Rektum

Stomach, Intestines, Rectum



Anuskope – Sphinkterskope
Anusscopes – Sphincteroscopes
Anusscopes – Sphinctérosopes
Anoscopios – Esfinteroscopios
Anoscopi – Sfinteroscopi



HIRSCHMANN

16 mm Ø	x = 65 mm	56-421-001
19 mm Ø	x = 65 mm	56-421-002
22 mm Ø	x = 65 mm	56-421-003



HIRSCHMANN

16 mm Ø	56-423-001
19 mm Ø	56-423-002
24 mm Ø	56-423-003
25 mm Ø	56-423-004

mit Kaltlicht
 with F.O. light
 avec lumière froide
 con de luz fría
 con per luce fredda

56-425-000

Kaltlichtadapter, ALLGAIER / Storz Anschluss
 Cold light, ALLGAIER / Storz connector
 Adaptateur lum. froide, connection ALLGAIER / Storz
 Adaptator luz fría, conexión ALLGAIER / Storz
 Adattatore luce freddo, attacco ALLGAIER / Storz

Analspreizer

Rectal specula

Spéculums pour le rectum

Espéculos rectales

Divaricatore anale

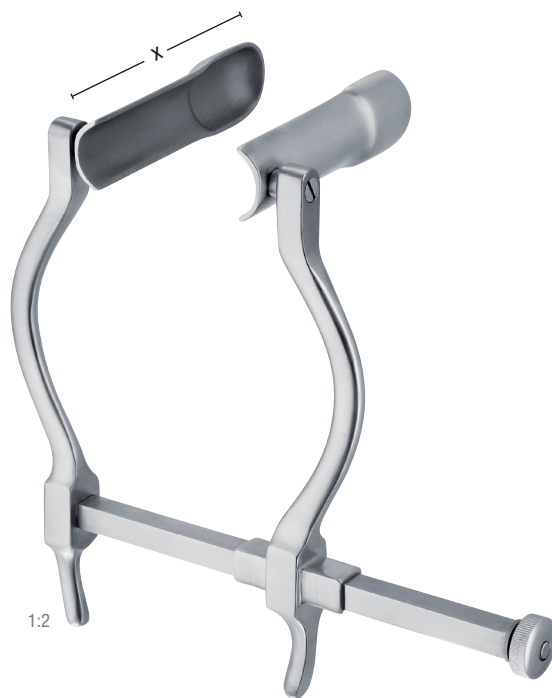

SMITH-BUIE

	x = 75 mm x 23 mm
150 mm – 6 "	56-391-150

Max. Spreizweite 115 mm

Max. spread 115 mm

Écartement maximal 115 mm

Apertura máxima 115 mm

Apertura massima 115 mm



Anal spreizer

Rectal specula

Spéculums pour le rectum

Espéculos rectales

Divaricatore anale



1:2

ALAN PARKS

140 mm – 5 ½"	368-143-000
---------------	-------------

komplett mit 2 Paar Valven und 1 Mittelvalve
 complete with 2 pair of blades and 1 center blade
 complet avec 2 paires des valves et 1 valve centrale
 completo con 2 juegos de valvas y 1 valva central
 completo con 2 paia di valve e 1 valva centrale

22 mm x 75 mm	368-143-070
---------------	-------------

Seitenvalven alleine (Paar)
 Lateral blades only (pair)
 Valves latérales seules (paire)
 Valvas laterales solas (par)
 Valve laterali solo (paio)

22 mm x 95 mm	368-143-090
---------------	-------------

Seitenvalven alleine (Paar)
 Lateral blades only (pair)
 Valves latérales seules (paire)
 Valvas laterales solas (par)
 Valve laterali solo (paio)

25 mm x 95 mm	368-143-093
---------------	-------------

Seitenvalven alleine (Paar)
 Lateral blades only (pair)
 Valves latérales seules (paire)
 Valvas laterales solas (par)
 Valve laterali solo (paio)



1:2

ALAN PARKS

140 mm – 5 ½"	368-144-000
---------------	-------------

komplett mit 2 Paar Valven und 1 Mittelvalve, mit Kaltlichtanschluss ALLGAIER/Wolf
 complete with 2 pair of blades and 1 center blade, with cold light connector ALLGAIER/Wolf
 complet avec 2 paires des valves et 1 valve centrale, avec raccord de lum. froide ALLGAIER/Wolf
 completo con 2 juegos de valvas y 1 valva central, con connector de luz fría ALLGAIER/Wolf
 completo con 2 paia di valve e 1 valva centrale, con attacco di luce fredda ALLGAIER/Wolf

368-144-002

Kaltlicht-Aufsatz alleine
 F.O. light carrier only
 Support lumière froide seule
 Soporte de luz fría sola
 Supporto per luce fredda solo

368-143-001

Sperrer alleine
 Specula only
 Speculum seules
 Espéculo sola
 Divaricatore solo

368-143-002

Mittelvalve alleine
 Central blade only
 Valve centrale seule
 Valva central sola
 Valva centrale solo

Rektoskop
Rectoscope

Rectoscope
Rectoscopio
Rettoscopio

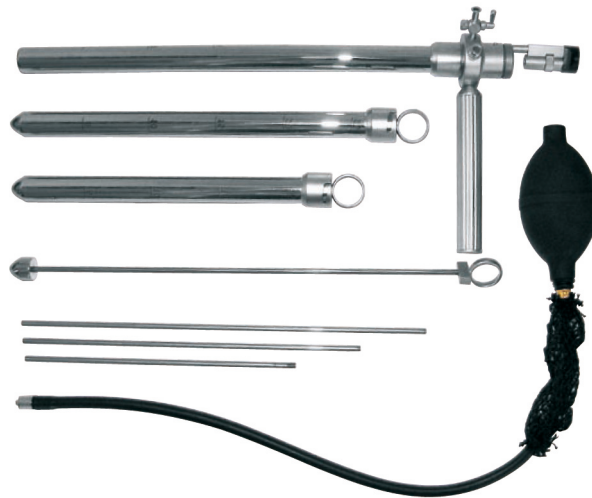

STRAUSS

368-157-000

Kaltlicht-Rektoskop, komplett:

F/O Rektoskopkopf mit Zweiwegehahn, Verschlussdeckel, Teleskop und Griff, je1 Rektoskoptubus in 200 mm, 250 mm und 300 mm mit 20 mm Ø, mit Obturator und F/O Lichtträger Wolf-Anschluss, Doppelgebläse mit Kaltlichteinrichtung

Cold-light rectoscope, complete:

F/O Rectoscope-head with two-way stop cock, lens cover and telescope handle, 3 rectoscope-tubes 20 mm Ø 200 mm, 250 mm and 300 mm with obturator and F/O light-carrier Wolf, with double blower, with cold light connection

Rectoscope à lumière froide, complet:

F/O tête de rectoscope avec robinet, protecteur de lentille, optique et manche, 3 tubes de rectoscope 20 mm Ø, 200 mm, 250 mm et 300 mm de longueur, avec mandrin et porte-lumière Wolf (F/O), souffleur et connecteur de lumière froide.

Rectoscopio de luz fría, completo:

F/O cabeza de rectoscopio, con robinete protector de lentes, óptica y mango, 3 tubos de rectoscopia de 20 mm, Ø 200 mm, 250 mm y 300 mm de longitud, con obturador y connector de luz fría Wolf y soplador.

Luce fredda-Rettoscopio, completo:

Testa di rettoscopio con fibre ottiche, con rubinetto a due vie, copri-lente e impugnatura per ottica, 3 tubi per rettoscopio 20 mm Ø, 200 mm, 250 mm e 300 mm con otturatore e cavo luce, insufflatore a doppia palla e connettore per cavo luce, allacciamento Wolf.

56-425-000

Kaltlichtadapter ALLGAIER/Storz

Cold light connector ALLGAIER/Storz
Raccord de lumière froide ALLGAIER/Storz
Connector de luz fría ALLGAIER/Storz
Attacco luce fredda ALLGAIER/Storz

Magen, Darm, Rektum

Stomach, Intestines, Rectum



Mastdarm-Biopsiezangen

Rectal biopsy forceps

Pinces pour la biopsie rectale
Pinzas para biopsia rectal
Pinze taglianti per biopsia rettale

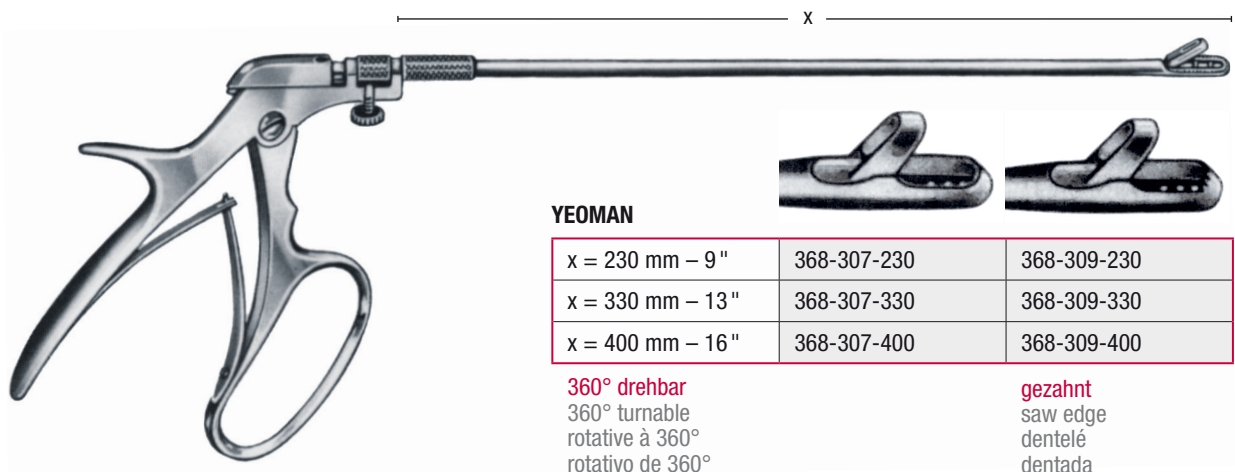

YEOMAN

x = 230 mm – 9"	368-307-230	368-309-230
x = 330 mm – 13"	368-307-330	368-309-330
x = 400 mm – 16"	368-307-400	368-309-400

360° drehbar
 360° turnable
 rotative à 360°
 rotativo de 360°
 rotativa di 360°

gezahnt
 saw edge
 dentelé
 dentada
 dentata

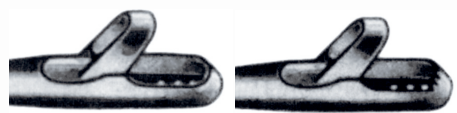

TURREL

x = 230 mm – 9"	368-317-230	368-319-230
x = 330 mm – 13"	368-317-330	368-319-330
x = 400 mm – 16"	368-317-400	368-319-400

360° drehbar
 360° turnable
 rotative à 360°
 rotativo de 360°
 rotativa di 360°

gezahnt
 saw edge
 dentelé
 dentada
 dentata

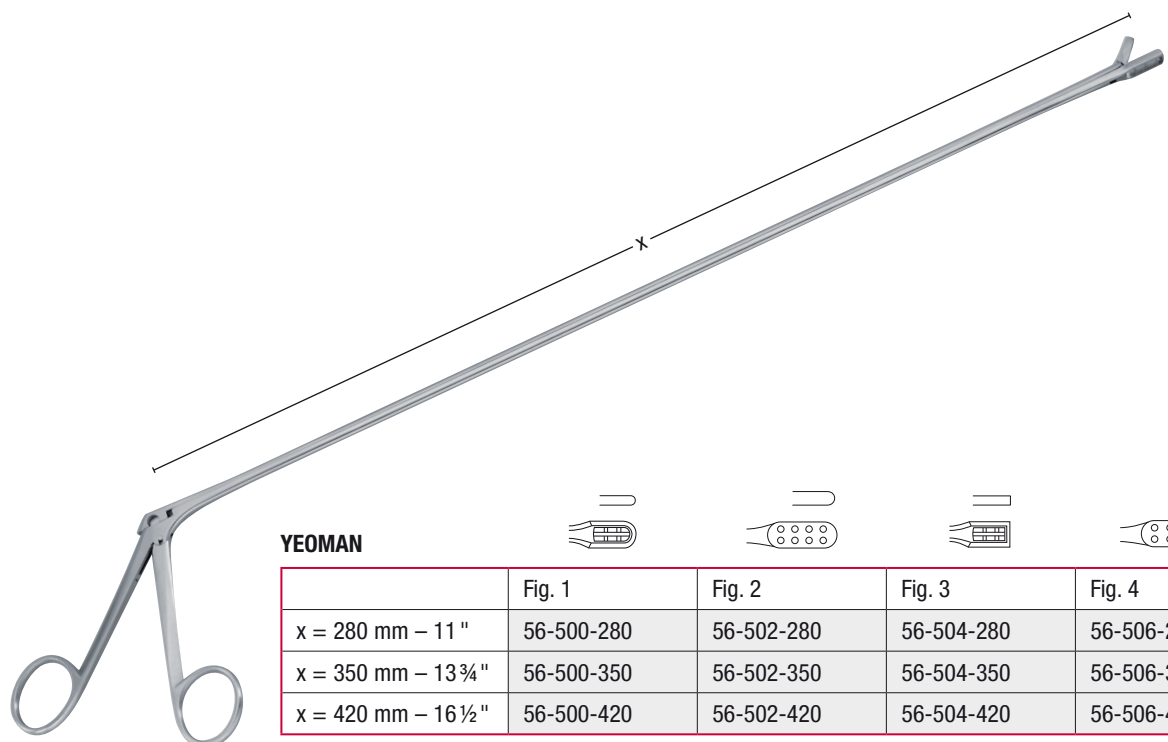

YEOMAN



	Fig. 1	Fig. 2	Fig. 3	Fig. 4
x = 280 mm – 11"	56-500-280	56-502-280	56-504-280	56-506-280
x = 350 mm – 13 3/4"	56-500-350	56-502-350	56-504-350	56-506-350
x = 420 mm – 16 1/2"	56-500-420	56-502-420	56-504-420	56-506-420

Flexible Zangen
Flexible forceps
Pinces flexibles
Pinzas flexibles
Pinze flessibili



	1.8 mm Ø	2.1 mm Ø	2.3 mm Ø	2.5 mm Ø	3.0 mm Ø	3.4 mm Ø
120 cm – 47 ¼"	AFF102-218-120	AFF102-221-120	AFF102-223-120	AFF102-225-120		
160 cm – 63"	AFF102-218-160	AFF102-221-160	AFF102-223-160	AFF102-225-160		
180 cm – 70 ¾"	AFF102-218-180	AFF102-221-180	AFF102-223-180	AFF102-225-180	AFF102-230-180	AFF102-234-180
230 cm – 90 ½"	AFF102-218-230	AFF102-221-230	AFF102-223-230	AFF102-225-230	AFF102-230-230	AFF102-234-230



	1.8 mm Ø	2.1 mm Ø	2.3 mm Ø	2.5 mm Ø	3.0 mm Ø	3.4 mm Ø
120 cm – 47 ¼"	AFF103-218-120	AFF103-221-120	AFF103-223-120	AFF103-225-120		
160 cm – 63"	AFF103-218-160	AFF103-221-160	AFF103-223-160	AFF103-225-160		
180 cm – 70 ¾"	AFF103-218-180	AFF103-221-180	AFF103-223-180	AFF103-225-180	AFF103-230-180	AFF103-234-180
230 cm – 90 ½"	AFF103-218-230	AFF103-221-230	AFF103-223-230	AFF103-225-230	AFF103-230-230	AFF103-234-230



	1.0 mm Ø	1.4 mm Ø	1.6 mm Ø	1.8 mm Ø	2.1 mm Ø	2.3 mm Ø
120 cm – 47 ¼"	AFF100-210-120	AFF100-214-120	AFF100-216-120	AFF100-218-120	AFF100-221-120	AFF100-223-120
160 cm – 63"	AFF100-210-160	AFF100-214-160	AFF100-216-160	AFF100-218-160	AFF100-221-160	AFF100-223-160
180 cm – 70 ¾"	AFF100-210-180	AFF100-214-180	AFF100-216-180	AFF100-218-180	AFF100-221-180	AFF100-223-180
230 cm – 90 ½"	AFF100-210-230	AFF100-214-230	AFF100-216-230	AFF100-218-230	AFF100-221-230	AFF100-223-230



	1.8 mm Ø	2.1 mm Ø	2.3 mm Ø
120 cm – 47 ¼"	AFF101-218-120	AFF101-221-120	AFF101-223-120
160 cm – 63"	AFF101-218-160	AFF101-221-160	AFF101-223-160
180 cm – 70 ¾"	AFF101-218-180	AFF101-221-180	AFF101-223-180
230 cm – 90 ½"	AFF101-218-230	AFF101-221-230	AFF101-223-230



Magen, Darm, Rektum

Stomach, Intestines, Rectum



Flexible Zangen
Flexible forceps
Pinces flexibles
Pinzas flexibles
Pinze flessibili



	1.8 mm Ø	2.1 mm Ø	2.3 mm Ø
120 cm – 47 ¼ "	AFF118-218-120	AFF118-221-120	AFF118-223-120
160 cm – 63 "	AFF118-218-160	AFF118-221-160	AFF118-223-160
180 cm – 70 ¾ "	AFF118-218-180	AFF118-221-180	AFF118-223-180
230 cm – 90 ½ "	AFF118-218-230	AFF118-221-230	AFF118-223-230



	1.0 mm Ø	1.4 mm Ø	1.6 mm Ø	1.8 mm Ø	2.3 cm Ø	3.0 cm Ø
120 cm – 47 ¼ "	AFF109-210-120	AFF109-214-120	AFF109-216-120	AFF109-218-120	AFF109-223-120	
160 cm – 63 "	AFF109-210-160	AFF109-214-160	AFF109-216-160	AFF109-218-160	AFF109-223-160	
180 cm – 70 ¾ "	AFF109-210-180	AFF109-214-180	AFF109-216-180	AFF109-218-180	AFF109-223-180	AFF109-230-180
230 cm – 90 ½ "	AFF109-210-230	AFF109-214-230	AFF109-216-230	AFF109-218-230	AFF109-223-230	AFF109-230-230



	1.8 mm Ø	2.3 mm Ø	3.0 mm Ø
120 cm – 47 ¼ "	AFF108-218-120	AFF108-223-120	
160 cm – 63 "	AFF108-218-160	AFF108-223-160	
180 cm – 70 ¾ "	AFF108-218-180	AFF108-223-180	AFF108-230-180
230 cm – 90 ½ "	AFF108-218-230	AFF108-223-230	AFF108-230-230

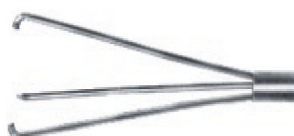

	1.0 mm Ø	1.8 mm Ø	2.3 mm Ø
120 cm – 47 ¼ "	AFF112-210-120	AFF112-218-120	AFF112-223-120
160 cm – 63 "	AFF112-210-160	AFF112-218-160	AFF112-223-160
180 cm – 70 ¾ "	AFF112-210-180	AFF112-218-180	AFF112-223-180
230 cm – 90 ½ "	AFF112-210-230	AFF112-218-230	AFF112-223-230



	1.8 mm Ø	2.3 mm Ø
120 cm – 47 ¼ "	AFF114-218-120	AFF114-223-120
160 cm – 63 "	AFF114-218-160	AFF114-223-160
180 cm – 70 ¾ "	AFF114-218-180	AFF114-223-180
230 cm – 90 ½ "	AFF114-218-230	AFF114-223-230



Hämorrhoidal-Zangen
Haemorrhoidal forceps
Pinces hémorroidales
Pinzas hemorroidales
Pinze emorroidali

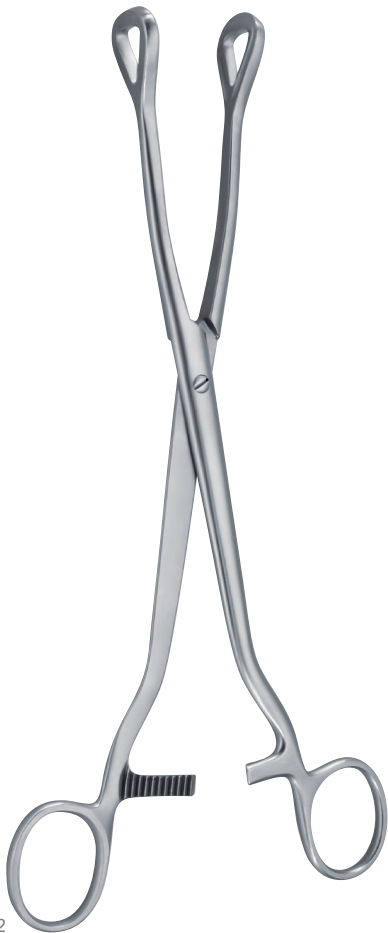

1:2
LUER

245 mm – 9¾"

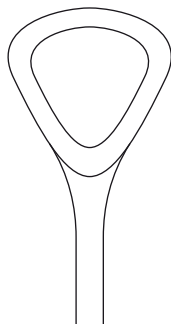

430-746-240

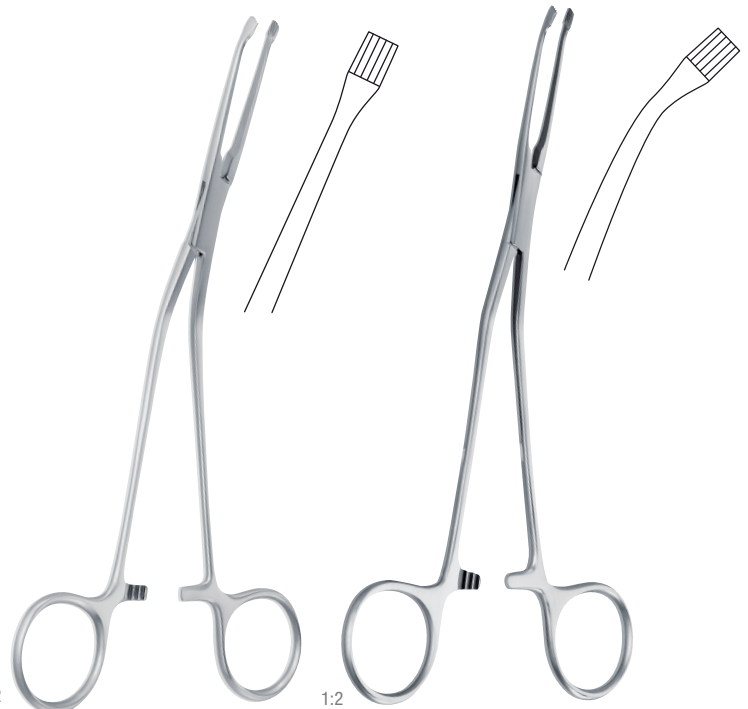

MCGIVNEY

1:2

1:2

190 mm – 7½"

13-488-001

13-488-002

1 x gebogen
single curved
courbé simple
curvado simple
curvatura singola

2 x gebogen
double curved
courbé double
curvado doble
curvatura doppia

Magen, Darm, Rektum

Stomach, Intestines, Rectum



Polypenfasszangen
Polypus grasping forceps
Pinces pour saisir les polypes
Pinzas para coger pólipos
Pinze per afferrare polipi

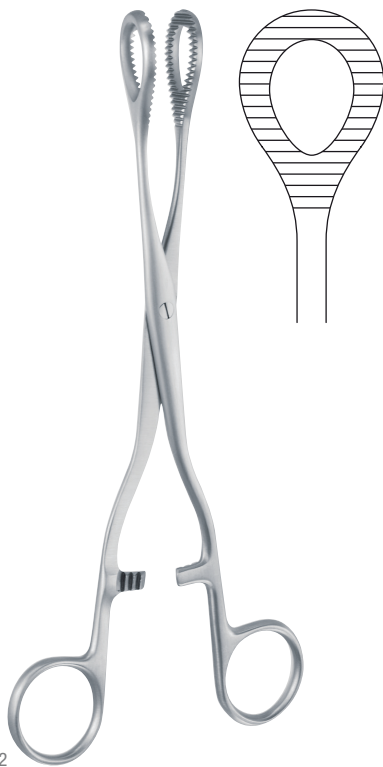

HEYWOOD-SMITH 1:2

200 mm – 8"

368-398-210

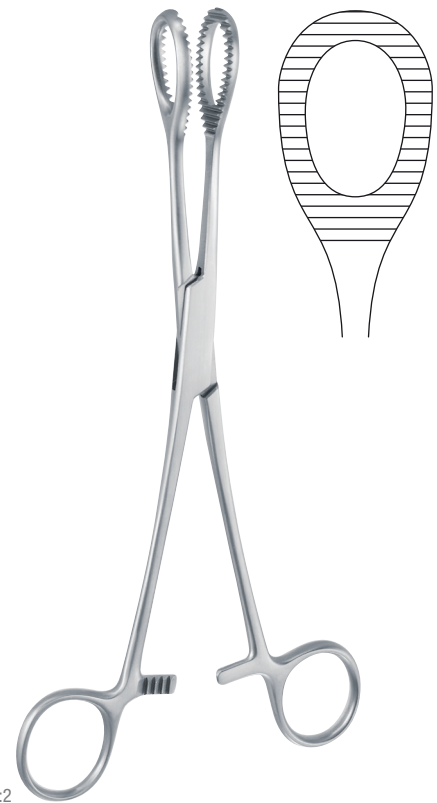

HEYWOOD-SMITH 1:2

210 mm – 8¼"

368-400-210

Hämorrhoidal-Ligatoren

Haemorrhoidal ligators

Ligateurs hémorroïdales
Ligadores hemorroidales
Legatori emorroidali

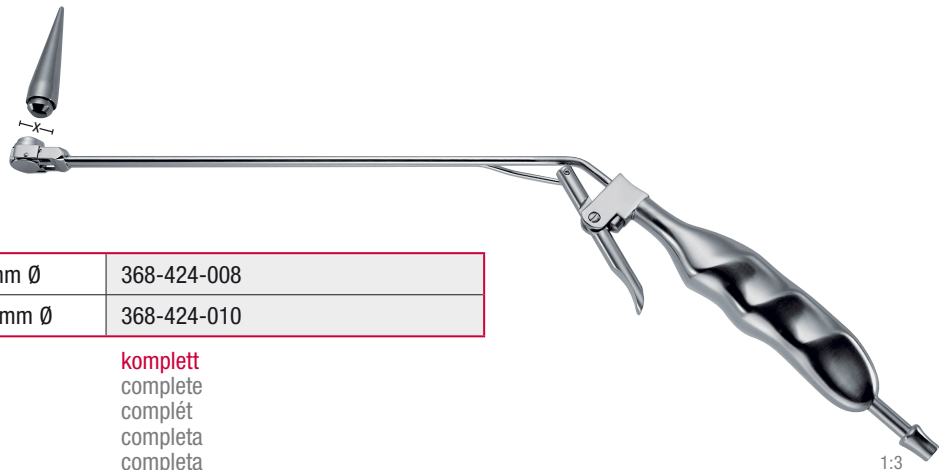

LURZ

x = 8 mm Ø	368-424-008
x = 10 mm Ø	368-424-010

komplett
complete
complét
completa
completa

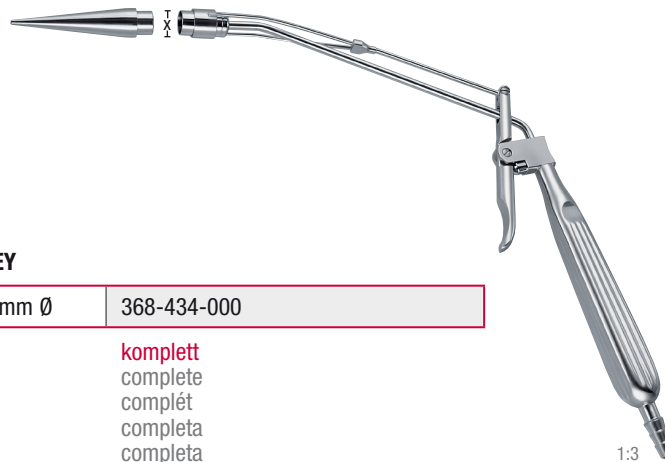

MCGIVNEY

x = 10 mm Ø	368-434-000
-------------	-------------

komplett
complete
complét
completa
completa

368-429-000

Gummiringe, Packung à 100 Stück
Rubber rings, package of 100 pieces
Anneaux de caoutchouc à ligatures, paquet de 100 pièces
Anillos de goma para ligaduras, paquete de 100 piezas
Anelli di gomma, pacchetto di 100 pezzi



Hämorrhoidal-Ligatoren

Haemorrhoidal ligators

Ligateurs hémorroïdales

Ligadores hemorroidales

Legatori emorroidali



RUDD

1:2

	x = 12 mm Ø	x = 12 mm Ø
315 mm – 12 ½ "	368-428-000	368-428-020

komplett
 complete
 complét
 completa
 completa

Ladekegel allein
 Cone piece only
 Cône seule
 Cono sólo
 Cono solo

368-429-000

Gummiringe, Packung à 100 Stück

Rubber rings, package of 100 pieces

Anneaux de caoutchouc à ligatures, paquet de 100 pièces

Anillos de goma para ligaduras, paquete de 100 piezas

Anelli di gomma, pacchetto di 100 pezzi

