

08

Wundhaken

Retractors

Ecarteurs

Separadores

Divaricatori



Wundhaken Retractors



Nasenhäkchen Nasal hooks

*Crochets nasales
Ganchitos nasales
Uncini nasali*



KILNER 1:2

150 mm – 6"
24-421-150



JOSEPH 1:2

150 mm – 6"
24-565-150



LANGE 1:2

220 mm – 8¾"
437-688-220



COTTLE 1:2

160 mm – 6¼"
437-682-160



FOMON 1:2

170 mm – 6¾"
346-553-170



COTTLE 1:2

150 mm – 6"



1:1

24-545-001



1:1

24-545-002



1:1

24-545-003

Nasenhäkchen Nasal hooks

Crochets nasales
Ganchitos nasales
Uncini nasali

ITERSON

160 mm – 6 ¼"	354-114-160	354-115-160
	scharf sharp pointu agudo acuto	stumpf blunt mousse romo smusso

GILLIES

	Fig. 1	Fig. 2
180 mm – 7"	24-425-001	24-425-002

JOSEPH

	2 mm	5 mm	7 mm	10 mm
160 mm – 6 ¼"	24-573-002	24-573-005	24-573-007	24-573-010

Wundhaken Retractors



Nasenhäkchen Nasal hooks

Crochets nasales
Ganchitos nasales
Uncini nasali



COTTLE-NEIVERT 1:2
200 mm – 8" 346-555-200



FOMON 1:2
160 mm – 6¼" 346-552-160



COTTLE 1:2
150 mm – 6" 346-552-140 437-705-010 437-705-020



NEIVERT 1:2
160 mm – 6¼" 437-708-160

Nasen- und Trachealhäkchen Nose and trachea hooks

*Ecarteurs nasales et tracheales
Separadores traqueales y nasales
Uncini tracheali e nasali*

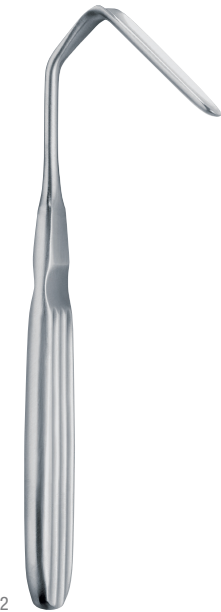

AUFRICHT

1:2

160 mm – 6¼"	160 mm – 6¼"
24-549-160	24-551-160

mit Kaltlichtaufsatz
with F.O. light carrier
avec support lumière froide
con guía de luz fría
con supporto per luce fredda



KILNER

1:2

100 mm – 4"	437-694-100
-------------	-------------



CONVERSE

1:2

120 mm – 4¾"	437-696-120
--------------	-------------



COTTLE

1:2

1:2

150 mm – 6"	437-709-150	437-710-150
-------------	-------------	-------------



JACKSON

1:2

150 mm – 6"	24-641-150
-------------	------------



LUKENS

1:2

170 mm – 6¾"	427-147-170
--------------	-------------

stumpf
blunt
mousse
romo
smusso

Wundhaken

Retractors



Trachealhäkchen

Trachea hooks

Ecarteurs tracheales
Separadores traqueales
Uncini tracheali

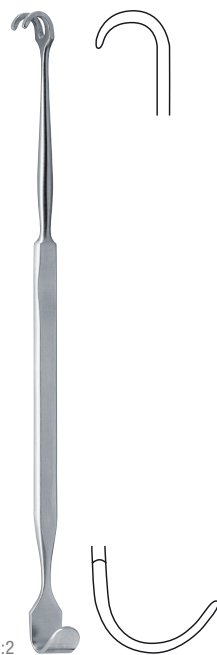

JACKSON 1:2

170 mm – 6 $\frac{2}{3}$ "	24-647-170
----------------------------	------------



JACKSON 1:2

180 mm – 7"	427-153-180	427-155-180
-------------	-------------	-------------

stumpf
 blunt
 mousse
 romo
 smusso

scharf
 sharp
 pointu
 agudo
 acuto

Wundhaken
Retractors

Ecarteurs
Separadores
Divaricatori



ROSE

1:2

130 mm – 5"

354-126-130



LUER

1:2

110 mm – 4 ¼"

318-124-110



SCHOENBORN

1:2

210 mm – 8 ¼"

354-507-210

Wundhaken Retractors



Wundhaken
Retractors
Ecarteurs
Separadores
Divaricatori



1:2

EMMET



1:1



1:1



1:1



1:1



1:1

	Fig. 1	Fig. 2	Fig. 3	Fig. 4	Fig. 5
220 mm – 8 3/4"	24-821-001	24-821-002	24-821-003	24-821-004	24-821-005



1:2



1:1



1:1



1:1



1:1

160 mm – 6 1/4"	24-021-001	24-021-002	24-021-003	24-021-004
-----------------	------------	------------	------------	------------

scharf
sharp
pointu
agudo
acuto



1:1



1:1



1:1



1:1

160 mm – 6 1/4"	24-023-001	24-023-002	24-023-003	24-023-004
-----------------	------------	------------	------------	------------

stumpf
blunt
mousse
romo
smusso

Wundhaken Retractors

Wundhaken Retractors

*Ecarteurs
Separadores
Divaricatori*



160 mm – 6 ¼ "	24-031-002	24-031-003	24-031-004
----------------	------------	------------	------------

flexibel, scharf
flexible, sharp
flexible, pointu
flexible, agudo
flessibile, acuto



160 mm – 6 ¼ "	24-033-002	24-033-003	24-033-004
----------------	------------	------------	------------

flexibel, stumpf
flexible, blunt
flexible, mousse
flexible, romo
flessibile, smusso

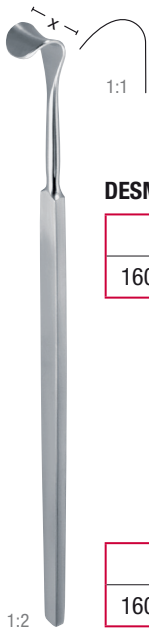

DESMARRES



	x = 8 mm	x = 10 mm	x = 12 mm
160 mm – 6 ¼ "	318-226-080	318-226-100	318-226-120



	x = 14 mm	x = 16 mm	x = 18 mm
160 mm – 6 ¼ "	318-226-140	318-226-160	318-226-180



KNAPP (ROLLET)

160 mm – 6 ¼ "	434-718-130	434-719-130	434-720-130
----------------	-------------	-------------	-------------

flexibel, scharf
flexible, sharp
flexible, pointu
flexible, agudo
flessibile, acuto

2 Zähne
2 Teeth
2 Dents
2 Dientes
2 Denti

3 Zähne
3 Teeth
3 Dents
3 Dientes
3 Denti

4 Zähne
4 Teeth
4 Dents
4 Dientes
4 Denti

Wundhaken Retractors



Wundhaken
Retractors
Ecarteurs
Separadores
Divaricatori



1:2

MINI-LANGENBECK

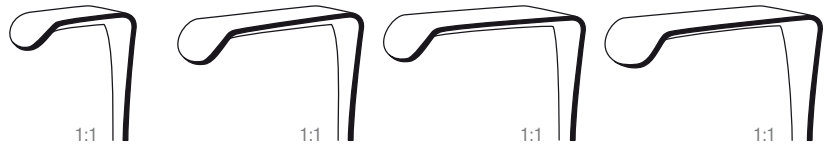

	10 mm x 6 mm	17 mm x 5 mm	20 mm x 6 mm	22 mm x 8 mm
160 mm – 6 ¼"	415-091-100	415-091-170	415-091-200	415-091-220



1:2

KOCHER

220 mm – 8 ¾"	415-236-010	415-236-020	415-236-030	415-236-040	415-236-060	415-236-080
---------------	-------------	-------------	-------------	-------------	-------------	-------------

scharf
sharp
pointu
agudo
acuto



220 mm – 8 ¾"	415-237-010	415-237-020	415-237-030	415-237-040	415-237-060	415-237-080
---------------	-------------	-------------	-------------	-------------	-------------	-------------







stumpf
blunt
mousse
romo
smusso







220 mm – 8 ¾"	415-238-010	415-238-020	415-238-030	415-238-040	415-238-060	415-238-080
---------------	-------------	-------------	-------------	-------------	-------------	-------------

halbscharf
semi-sharp
semi-pointu
semi-agudo
semi-acuto



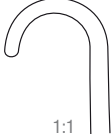

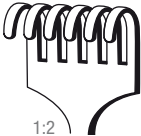

Wundhaken
Retractors
Ecarteurs
Separadores
Divaricatori

					
VOLKMANN 1:1	1:2	1:2	1:2	1:2	1:2
215 mm – 8½"	24-121-001	24-121-002	24-121-003	24-121-004	24-121-006

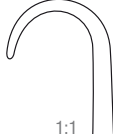
scharf
sharp
pointu
agudo
acuto

					
1:1	1:2	1:2	1:2	1:2	1:2
215 mm – 8½"	24-123-001	24-123-002	24-123-003	24-123-004	24-123-006

stumpf
blunt
mousse
romo
smusso

					
1:1	1:2	1:2	1:2	1:2	1:2
215 mm – 8½"	415-218-010	415-218-020	415-218-030	415-218-040	415-218-060

halbscharf
semi-sharp
semi-pointu
semi-agudo
semi-acuto



1:2

Wundhaken Retractors



Wundhaken
Retractors
Ecarteurs
Separadores
Divaricatori



1:2

VOLKMANN

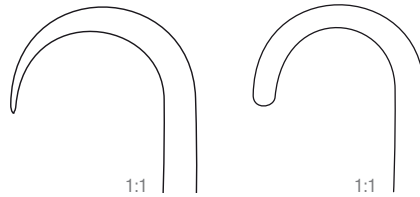

1:1

1:1

215 mm – 8½"	415-226-010	415-227-010
--------------	-------------	-------------

scharf
sharp
pointu
agudo
acuto

stumpf
blunt
mousse
romo
smusso



1:2



1:1

SENN-MUELLER

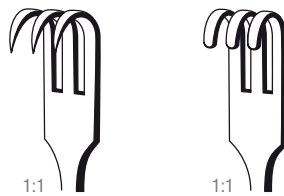

1:1

1:1

160 mm – 6¼"	24-097-160	24-099-160
--------------	------------	------------

scharf
sharp
pointu
agudo
acuto

stumpf
blunt
mousse
romo
smusso



1:2

1:1

KILNER

155 mm – 6"	24-095-155
-------------	------------

1:1

Wundhaken Retractors

Wundhaken
Retractors
Ecarteurs
Separadores
Divaricatori



1:2
**STRANDELL-
STILLE**

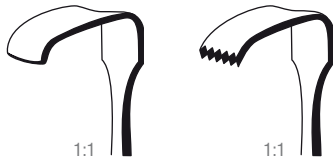

	20 mm x 6 mm	20 mm x 6 mm
190 mm – 7½"	415-187-010	415-187-020

gezahnt
saw edge
dentelé
dentado
dentato

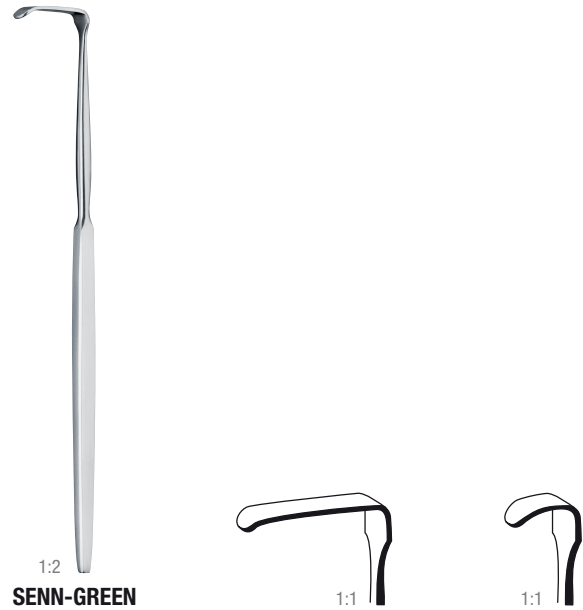

1:2
SENN-GREEN

	20 mm x 6 mm	10 mm x 6 mm
150 mm – 6"	318-236-200	318-236-100



**RAGNELL-
DAVIS**

140 mm – 5½"
415-160-140



COTTLE

150 mm – 6"
437-706-140



CRILE

110 mm – 4¼"
318-123-110

Wundhaken

Retractors



Wundhaken
Retractors
Ecarteurs
Separadores
Divaricatori

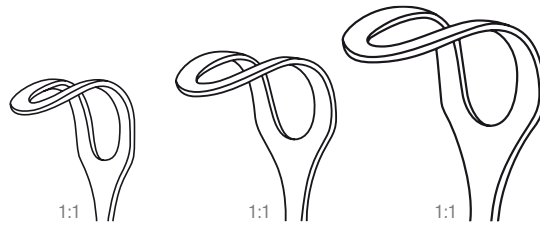

MIDDELDORPF

14 mm x 17 mm	20 mm x 22 mm	26 mm x 30 mm
215 mm – 8½"	220 mm – 8¾"	235 mm – 9¼"
24-161-001	24-161-002	24-161-003



MEYERDING



	18 mm x 7 mm	16 mm x 5 mm
180 mm – 7"	318-298-010	318-298-020



	7 mm x 4 mm	7 mm x 4 mm
180 mm – 7"	318-298-030	318-298-040

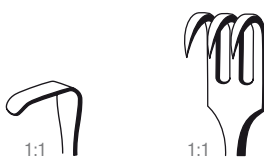

	10 mm x 3 mm	10 mm x 4 mm
180 mm – 7"	318-298-050	318-298-060

1:2

Wundhaken
Retractors

Ecarteurs
Separadores
Divaricatori



1:2

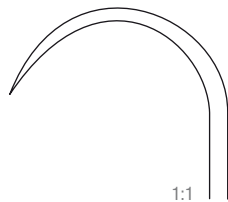

1:1

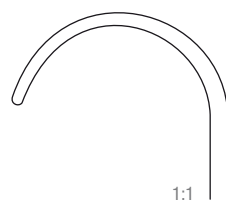

1:1

KOERTE

	26 mm x 40 mm	26 mm x 40 mm
235 mm – 9¼"	24-145-235	24-147-235

scharf
sharp
pointu
agudo
acuto

stumpf
blunt
mousse
romo
smusso



1:2

GREEN

215 mm – 8½"	318-344-220
--------------	-------------

Wundhaken Retractors



Wundhaken
Retractors
Ecarteurs
Separadores
Divaricatori



1:2

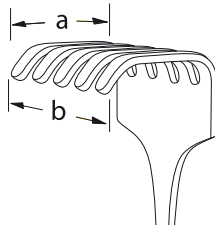

ISRAEL

	a = 40 mm – b = 40 mm	a = 45 mm – b = 50 mm
250 mm – 9¾"	318-360-400	318-360-500

4 Zähne
4 Teeth
4 Dents
4 Dientes
4 Denti

5 Zähne
5 Teeth
5 Dents
5 Dientes
5 Denti

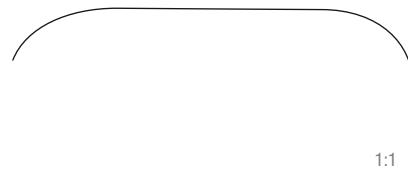

1:1

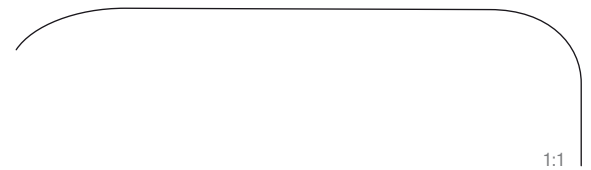

1:1

	a = 50 mm – b = 60 mm	a = 70 mm – b = 70 mm
250 mm – 9¾"	318-360-600	318-360-700

6 Zähne
6 Teeth
6 Dents
6 Dientes
6 Denti

6 Zähne
6 Teeth
6 Dents
6 Dientes
6 Denti



1:2

LANGENBECK



	Fig. 1	Fig. 2	Fig. 3
	30 mm x 11 mm	30 mm x 14 mm	30 mm x 16 mm
220 mm – 8¾"	318-306-010	318-306-020	318-306-030



	Fig. 4	Fig. 5
	40 mm x 11 mm	50 mm x 11 mm
220 mm – 8¾"	318-306-040	318-306-050

Wundhaken
Retractors
Ecarteurs
Separadores
Divaricatori



LANGENBECK



	Fig. 1	Fig. 2	Fig. 3
	30 mm x 11 mm	30 mm x 14 mm	30 mm x 16 mm
210 mm – 8¼"	24-169-001	24-169-002	24-169-003



	Fig. 4	Fig. 5
	40 mm x 11 mm	50 mm x 11 mm
210 mm – 8¼"	24-169-004	24-169-005



**KOCHER-LANGENBECK
(OBWEGESER)**

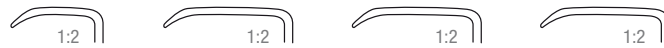

	25 mm x 6 mm	35 mm x 8 mm	35 mm x 11 mm	35 mm x 15 mm
215 mm – 8½"	415-313-010	415-313-020	415-313-030	415-313-040



	42 mm x 11 mm	55 mm x 11 mm	70 mm x 14 mm
215 mm – 8½"	415-313-050	415-313-060	415-313-070



	80 mm x 12 mm	80 mm x 16 mm
215 mm – 8½"	415-313-080	415-313-090

Wundhaken Retractors



Wundhaken
Retractors
Ecarteurs
Separadores
Divaricatori



CUSHING



	x = 8 mm	x = 10 mm	x = 12 mm	x = 14 mm	x = 16 mm	x = 18 mm
200 mm – 8"	318-228-080	318-228-100	318-228-120	318-228-140	318-228-160	318-228-180
240 mm – 9½"	415-168-080	415-168-100	415-168-120	415-168-140	415-168-160	415-168-180



OBWEGESER



	40 mm x 11 mm	55 mm x 11 mm
220 mm – 8¾"	348-589-400	348-589-550



	80 mm x 16 mm
220 mm – 8¾"	348-589-800

Wundhaken Retractors

Wundhaken
Retractors
Ecarteurs
Separadores
Divaricatori



1:2

OBWEGESER

1:1

1:1

	42 mm x 10 mm	70 mm x 11 mm
220 mm – 8 ¾"	348-591-220	348-593-220



1:2

OBWEGESER

155 mm – 6"	348-597-160
-------------	-------------



1:2

OBWEGESER

	x = 8 mm	x = 10 mm
160 mm – 6 ¼"	348-599-080	348-599-100

biegsam
malleable
malléable
maleable
flessibile

Wundhaken

Retractors



Wundhaken
Retractors
Ecarteurs
Separadores
Divaricatori

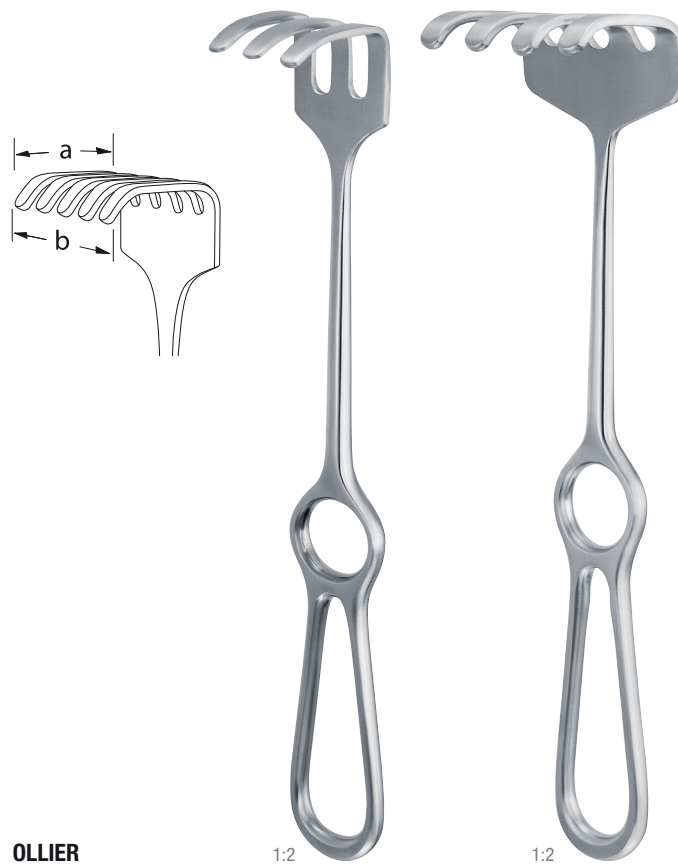

OLLIER

1:2

1:2

	a = 36 mm – b = 30 mm	a = 36 mm – b = 60 mm
225 mm – 8 ¾"	24-135-003	24-135-004

Wundhaken Retractors

Wundhaken
Retractors
Ecarteurs
Separadores
Divaricatori



KOCHER 1:2

	25 mm x 8 mm	55 mm x 11 mm	40 mm x 12 mm	75 mm x 12 mm	85 mm x 12 mm	100 mm x 12 mm
210 mm – 8¼"	318-326-080	318-326-550	318-326-400	318-326-750	318-326-850	318-326-100



1:2

LANGENBECK

	55 mm x 20 mm	60 mm x 20 mm
210 mm – 8¼"	318-311-220	318-311-210



1:2

LANGENBECK

	85 mm x 15 mm
210 mm – 8¼"	318-313-210

Griff vertikal zum Blatt
Handle vertical to the blade
Poignée verticale à la lame
Mango vertical a la hoja
Manico verticale verso la lama

Wundhaken Retractors



Wundhaken
Retractors
Ecarteurs
Separadores
Divaricatori

SAUERBRUCH

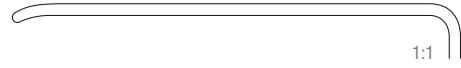
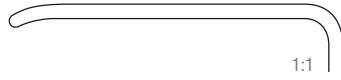

	45 mm x 15 mm	60 mm x 23 mm
225 mm – 8¾"	318-490-450	318-490-600

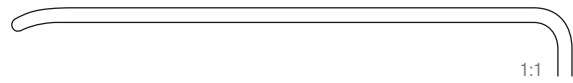

	75 mm x 20 mm
220 mm – 8¾"	318-490-750

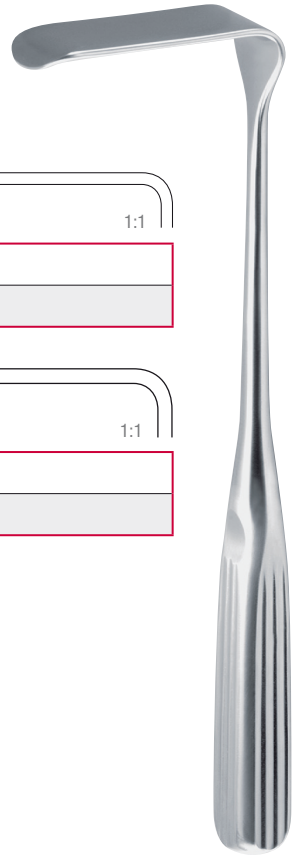

LAHEY

190 mm – 7½"
28 mm x 6 mm
318-300-190

1:2



1:2

KOCHER

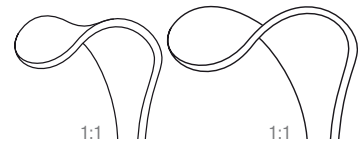

	19 mm x 12 mm	21 mm x 14 mm
190 mm – 7½"	318-328-190	318-328-210

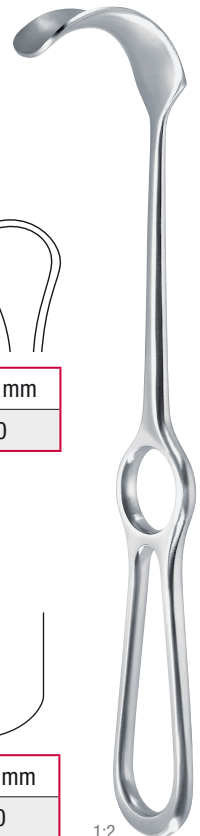

1:2

KOCHER

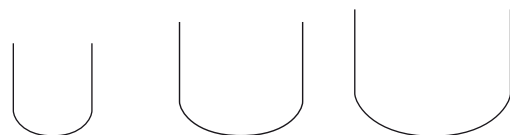

	40 mm x 10 mm	40 mm x 15 mm	40 mm x 20 mm
220 mm – 8¾"	318-336-100	318-336-150	318-336-200

Wundhaken
Retractors
Ecarteurs
Separadores
Divaricatori



1:2

KOCHER

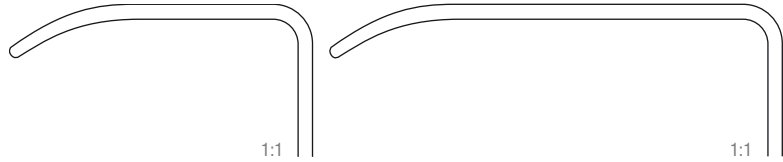

1:1

1:1

	40 mm x 18 mm	60 mm x 20 mm
230 mm – 9"	415-311-180	415-311-200

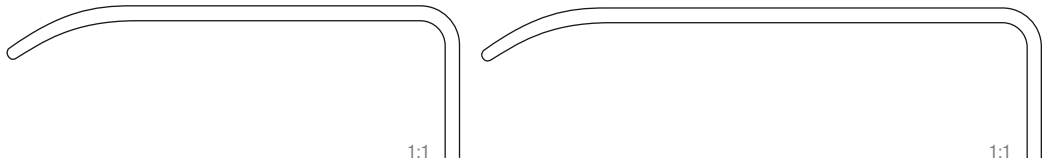

1:1

1:1

	60 mm x 25 mm	75 mm x 30 mm
230 mm – 9"	415-311-250	415-311-300



1:1

	75 mm x 40 mm
230 mm – 9"	415-311-400



1:2

RICHARDSON

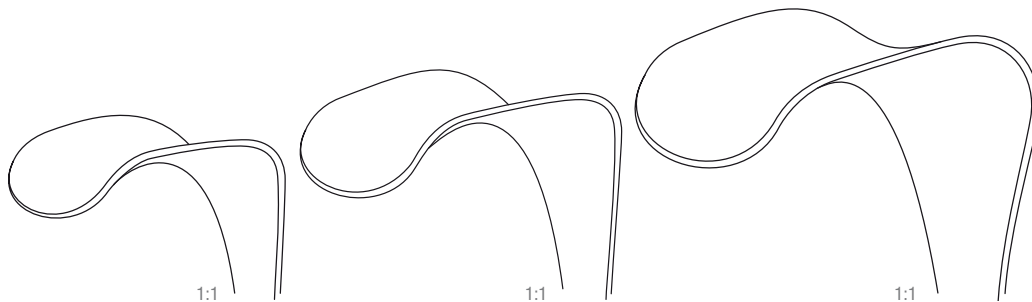

1:1

1:1

1:1

	25 mm x 20 mm	36 mm x 28 mm	44 mm x 38 mm
240 mm – 9½"	24-177-025	24-177-030	24-177-038

Wundhaken Retractors



Wundhaken
Retractors
Ecarteurs
Separadores
Divaricatori



RICHARDSON-EASTMAN

	Fig. 1	Fig. 2
	280 mm – 11"	260 mm – 10¼"
	49 mm x 38 mm	36 mm x 28 mm
	71 mm x 43 mm	28 mm x 20 mm
318-136-010	x	
318-136-020		x
318-136-000	x	x

RICHARDSON

240 mm – 9½"
52 mm x 22 mm
415-391-240

KELLY

260 mm – 10¼"
65 mm x 50 mm
318-152-260

Wundhaken Retractors

Wundhaken
Retractors

Ecarteurs
Separadores
Divaricatori



HOESEL

260 mm – 10 ¼"

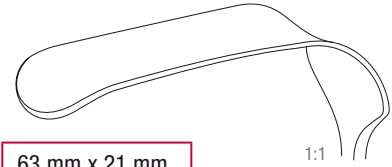

63 mm x 21 mm

415-401-010

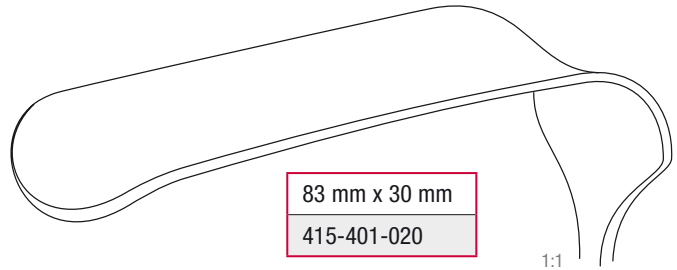

83 mm x 30 mm

415-401-020

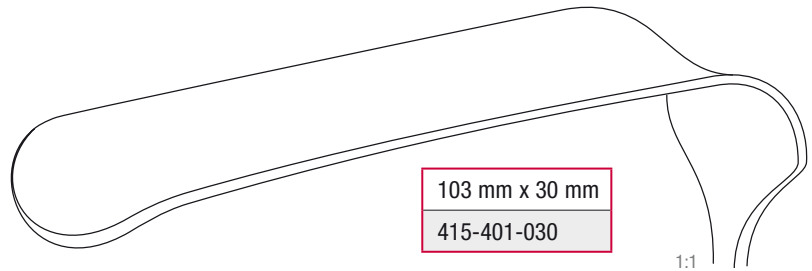

103 mm x 30 mm

415-401-030

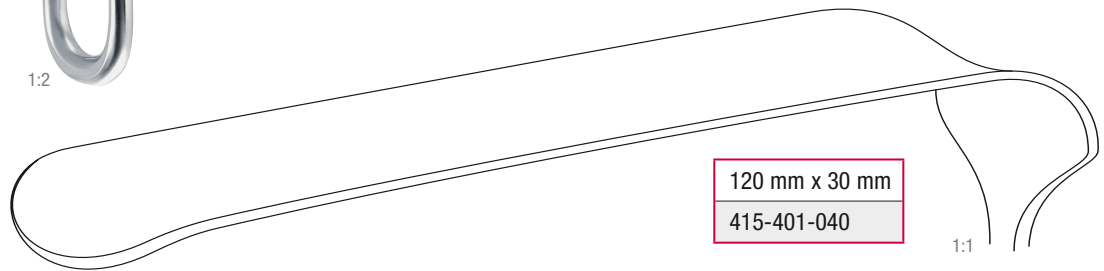

120 mm x 30 mm

415-401-040

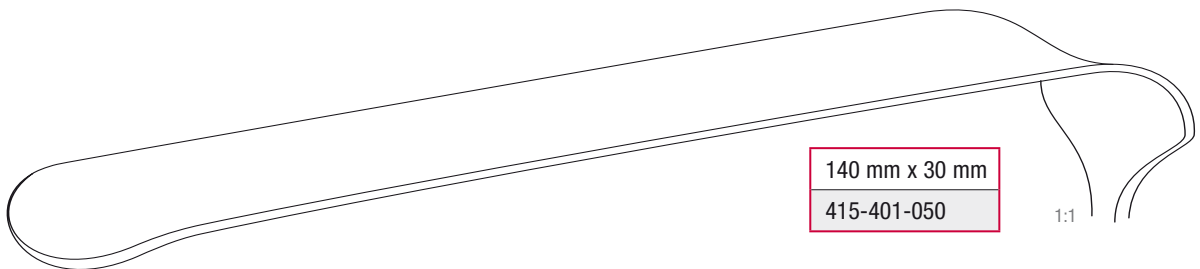

140 mm x 30 mm

415-401-050

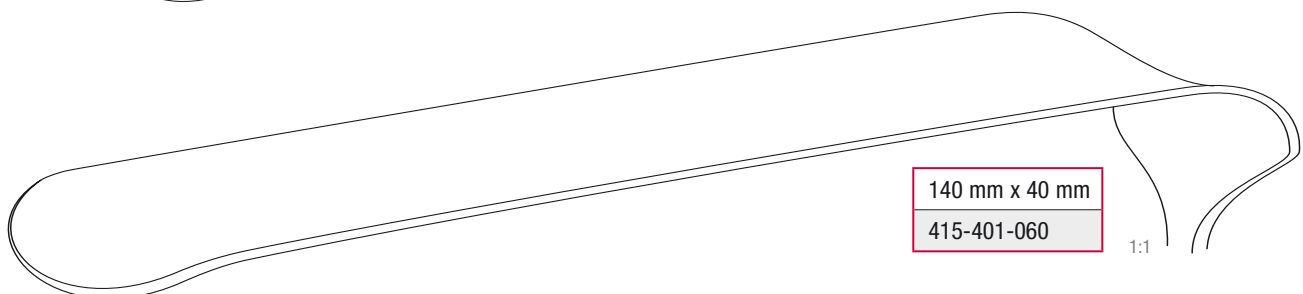

140 mm x 40 mm

415-401-060

Wundhaken Retractors



Wundhaken
Retractors
Ecarteurs
Separadores
Divaricatori



MEYERDING

200 mm – 8"	220 mm – 8 ¾"
50 mm x 16 mm	75 mm x 25 mm
318-494-010	318-494-020

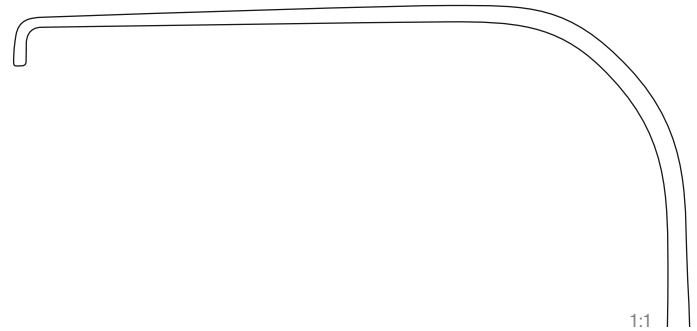
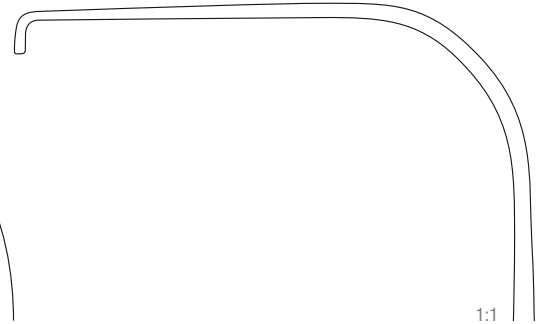
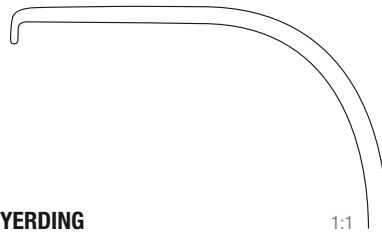

240 mm – 9 ½"
90 mm x 50 mm
318-494-030

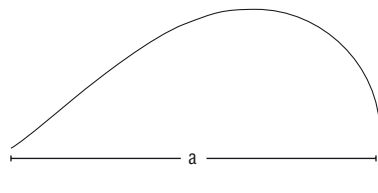

FRITSCH

240 mm – 9 ½"	a = 32 mm – b = 40 mm	24-701-000
240 mm – 9 ½"	a = 45 mm – b = 40 mm	24-701-001
240 mm – 9 ½"	a = 45 mm – b = 50 mm	24-701-002
240 mm – 9 ½"	a = 45 mm – b = 60 mm	24-701-003
240 mm – 9 ½"	a = 45 mm – b = 75 mm	24-701-004
240 mm – 9 ½"	a = 65 mm – b = 85 mm	24-701-005

Wundhaken Retractors

Wundhaken
Retractors
Ecarteurs
Separadores
Divaricatori



SIMON

	115 mm x 22 mm	115 mm x 27 mm
280 cm – 11 "	318-476-220	318-476-270

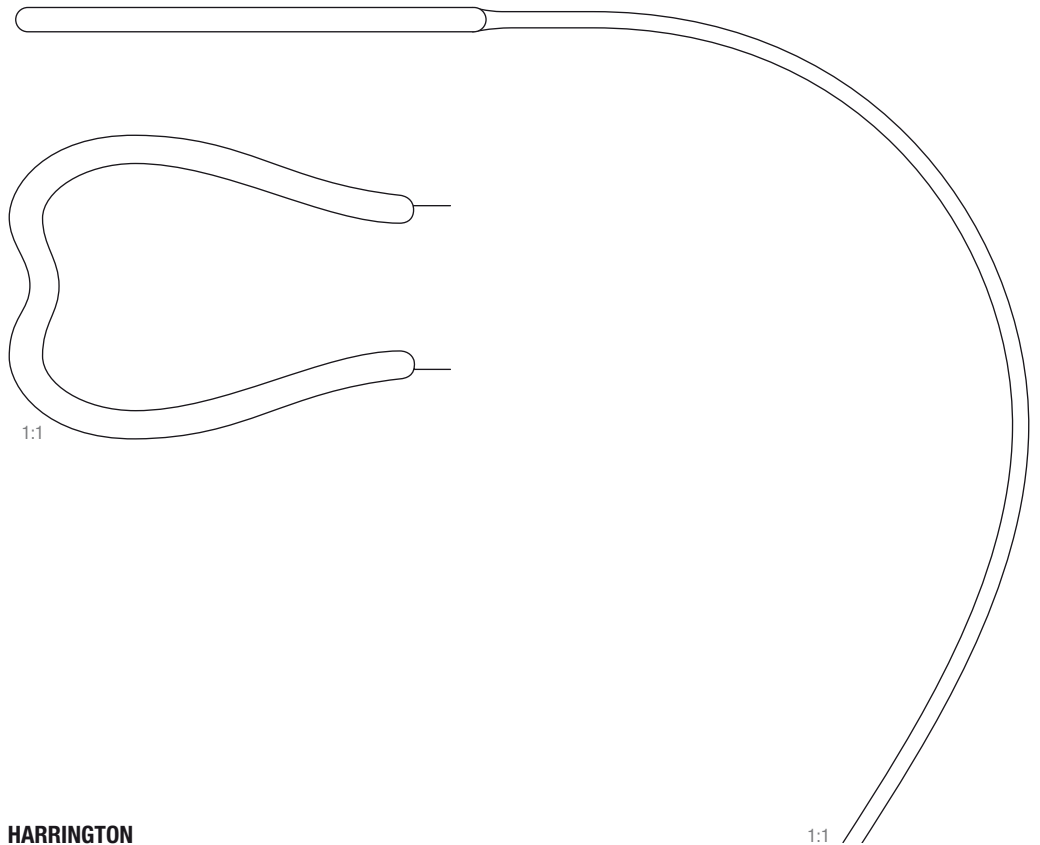

HARRINGTON

	127 mm x 40 mm	127 mm x 62 mm
320 mm – 12½ "	24-751-001	24-751-002

Wundhaken Retractors



Wundhaken
Retractors
Ecarteurs
Separadores
Divaricatori



1:2

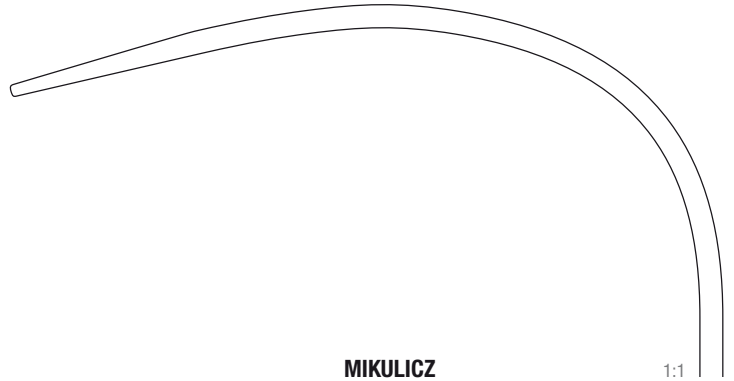

MIKULICZ

1:1

	95 mm x 35 mm
260 mm – 10 1/4"	24-221-095

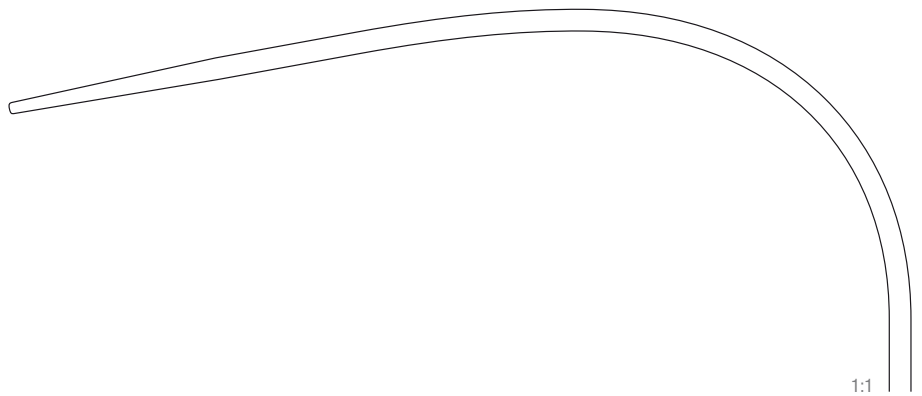

1:1

120 mm x 50 mm
24-221-120

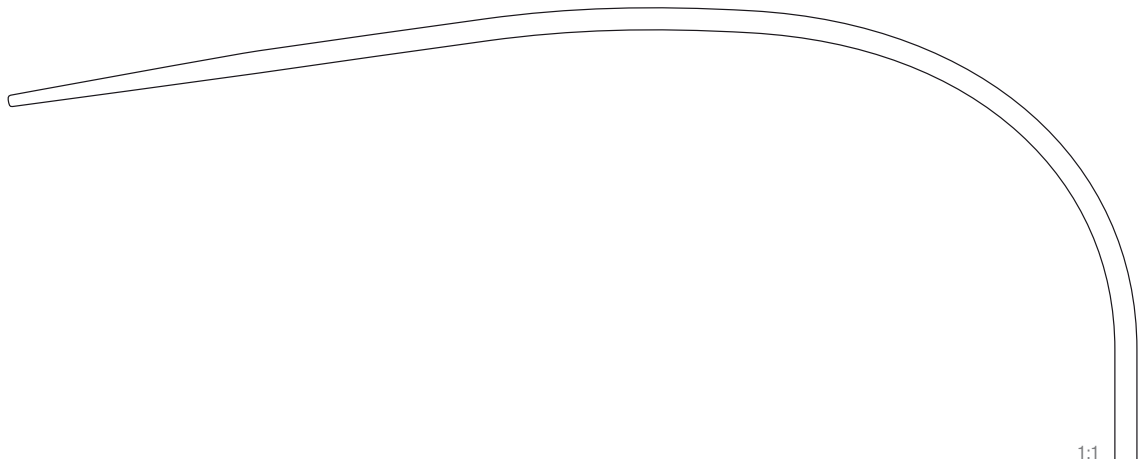

1:1

150 mm x 50 mm	180 mm x 50 mm
24-221-150	24-221-180

Wundhaken
Retractors

Ecarteurs
Separadores
Divaricatori



1:2

MIKULICZ

260 mm – 10 1/4"	90 mm x 50 mm	24-225-090
------------------	---------------	------------



1:2

DAVIDSON

	a = 75 mm – b = 50 mm	a = 75 mm – b = 90 mm
160 mm – 6 1/4"	318-492-500	318-492-900

Wundhaken

Retractors



Wundhaken
Retractors
Ecarteurs
Separadores
Divaricatori

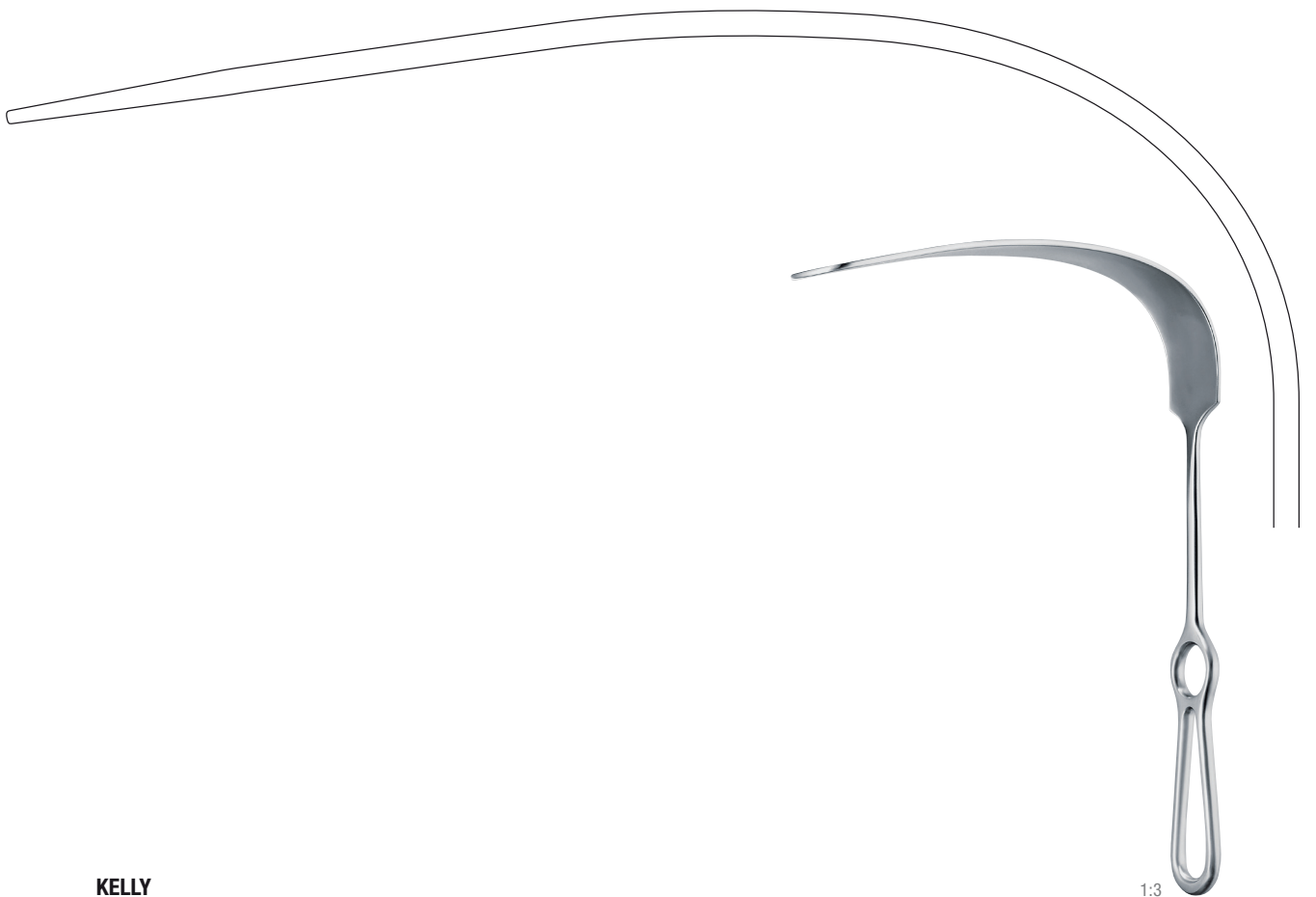

KELLY

1:3

	160 mm x 38 mm	190 mm x 38 mm	160 mm x 57 mm	190 mm x 57 mm
270 mm – 10 3/4 "	318-381-380	318-381-381	318-381-570	318-381-571

Wundhaken Retractors

Wundhaken
Retractors

Ecarteurs
Separadores
Divaricatori



1:2

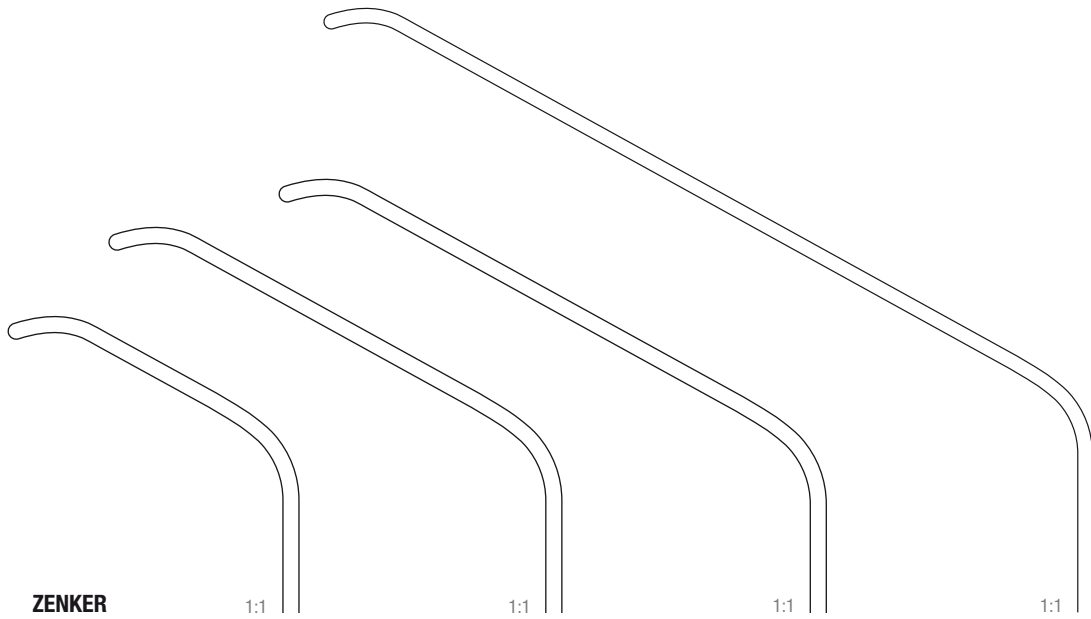

ZENKER

250 mm – 9¾"	260 mm – 10¼"	275 mm – 10¾"	290 mm – 11½"
35 mm x 8 mm	60 mm x 12 mm	75 mm x 12 mm	120 mm x 12 mm
415-319-350	415-319-600	415-319-750	415-319-100

Wundhaken

Retractors



Wundhaken
Retractors
Ecarteurs
Separadores
Divaricatori



COOLEY 1:2



1:2



1:2

250 mm – 9¾"	250 mm – 9¾"	270 mm – 10½"
415-589-010	415-589-020	415-589-030

rechts
 right
 droite
 derecha
 destra

rechts, gerieft
 right, serrated
 droite, strié
 derecha, estriada
 destra, zigrinato

links
 left
 gauche
 izquierda
 sinistra

Wundhaken
Retractors

Ecarteurs
Separadores
Divaricatori



1:2

1:1

1:1

1:1

MIDDELDORPF

	45 mm x 45 mm	45 mm x 50 mm	55 mm x 70 mm
255 mm – 10"	415-437-010	415-437-020	415-437-030

Wundhaken Retractors



Wundhaken
Retractors
Ecarteurs
Separadores
Divaricatori

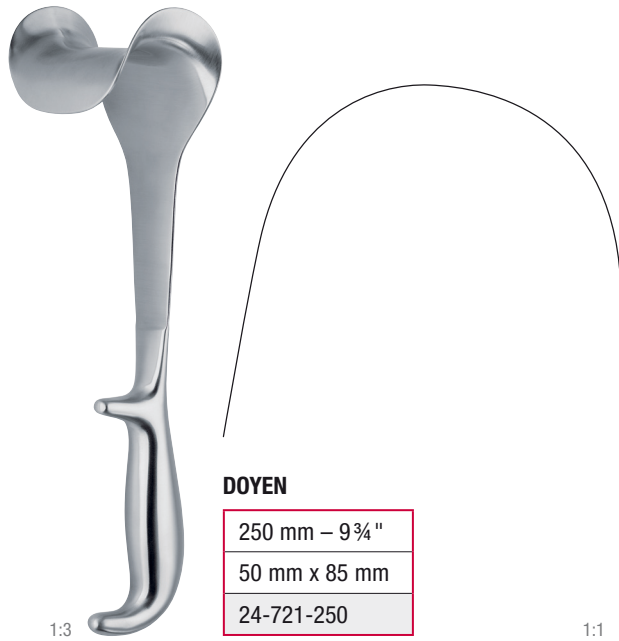

DOYEN

250 mm – 9¾"
50 mm x 85 mm
24-721-250



TUFFIER

230 mm – 9"
64 mm x 60 mm
415-477-230



KOCHER

225 mm – 8¾"
70 mm x 25 mm
318-368-220



KOCHER

	250 mm – 9¾"
80 mm x 45 mm	24-233-042
80 mm x 55 mm	24-233-050
80 mm x 65 mm	24-233-060

Wundhaken Retractors

Wundhaken
Retractors

Ecarteurs
Separadores
Divaricatori



MARTIN

250 mm – 9¾"	105 mm x 27 mm	415-497-250
--------------	----------------	-------------

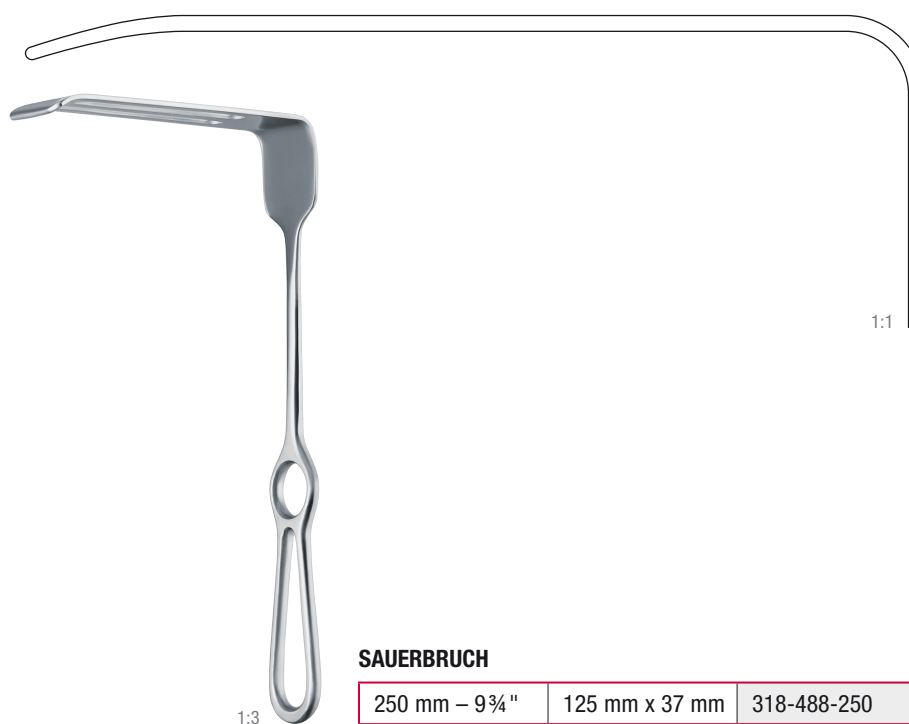

SAUERBRUCH

250 mm – 9¾"	125 mm x 37 mm	318-488-250
--------------	----------------	-------------

Wundhaken Retractors



Wundhaken
Retractors
Ecarteurs
Separadores
Divaricatori

HEANEY

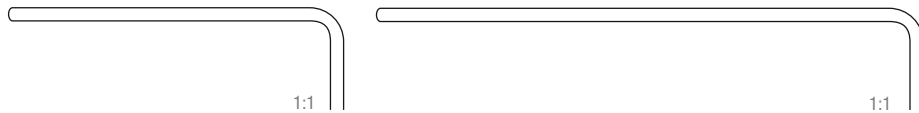

	45 mm x 25 mm	73 mm x 28 mm
270 mm – 10 3/4"	318-478-450	318-478-730

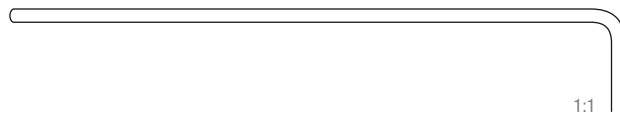

82 mm x 28 mm
318-478-820

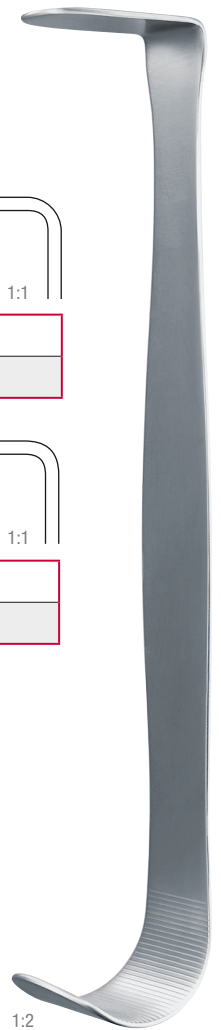

1:2

CORYLLOS

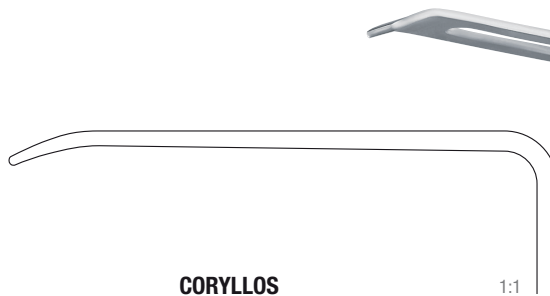

	82 mm x 22 mm
240 mm – 9 1/2"	318-486-220

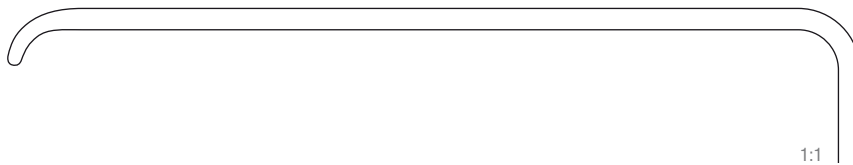

108 mm x 43 mm
318-486-430

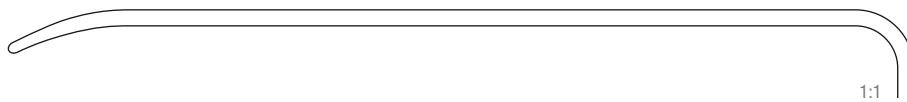

115 mm x 65 mm
318-486-650

1:2



Wundhaken Retractors

Wundhaken
Retractors
Ecarteurs
Separadores
Divaricatori



1:2

BRUNNER

250 mm – 9¾"

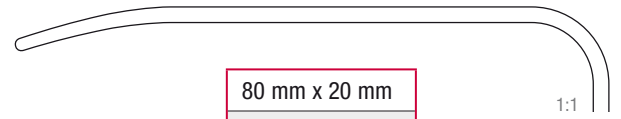

80 mm x 20 mm
24-741-080

1:1

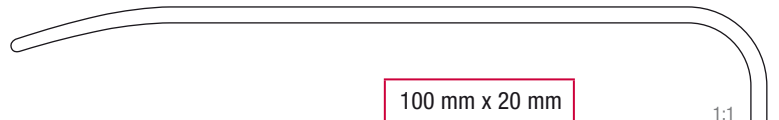

100 mm x 20 mm
24-741-100

1:1

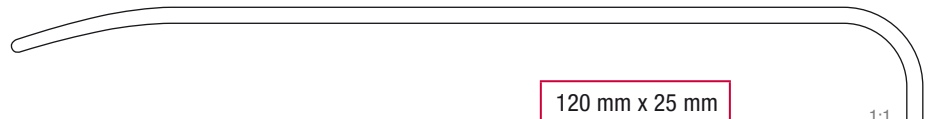

120 mm x 25 mm
24-741-120

1:1

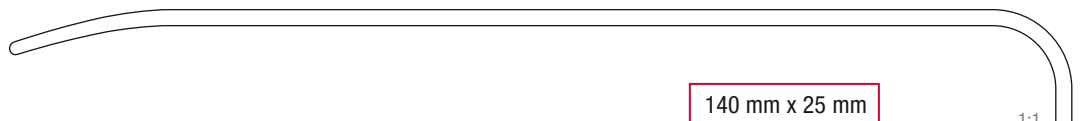

140 mm x 25 mm
24-741-140

1:1

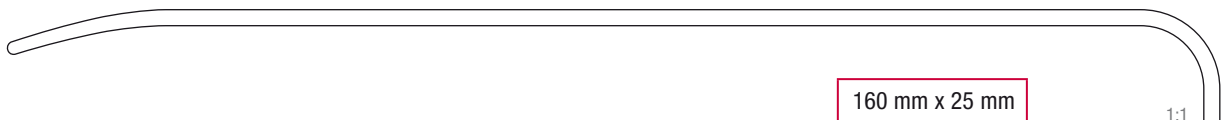

160 mm x 25 mm
24-741-160

1:1



180 mm x 30mm
24-741-180

1:1

Wundhaken Retractors



08

Wundhaken
Retractors
Ecarteurs
Separadores
Divaricatori



BRUNNER

1:2

240 mm – 9½"	142 mm x 25 mm	415-553-240
--------------	----------------	-------------

Wundhaken Retractors

Wundhaken
Retractors
Ecarteurs
Separadores
Divaricatori



GIL-VERNET



	x = 8 mm	x = 11 mm	x = 15 mm	x = 17 mm	x = 20 mm	x = 23 mm
240 mm – 9½"	415-170-080	415-170-110	415-170-150	415-170-170	415-170-200	415-170-230

biegsam
malleable
malléable
maleable
malleabile

1:2

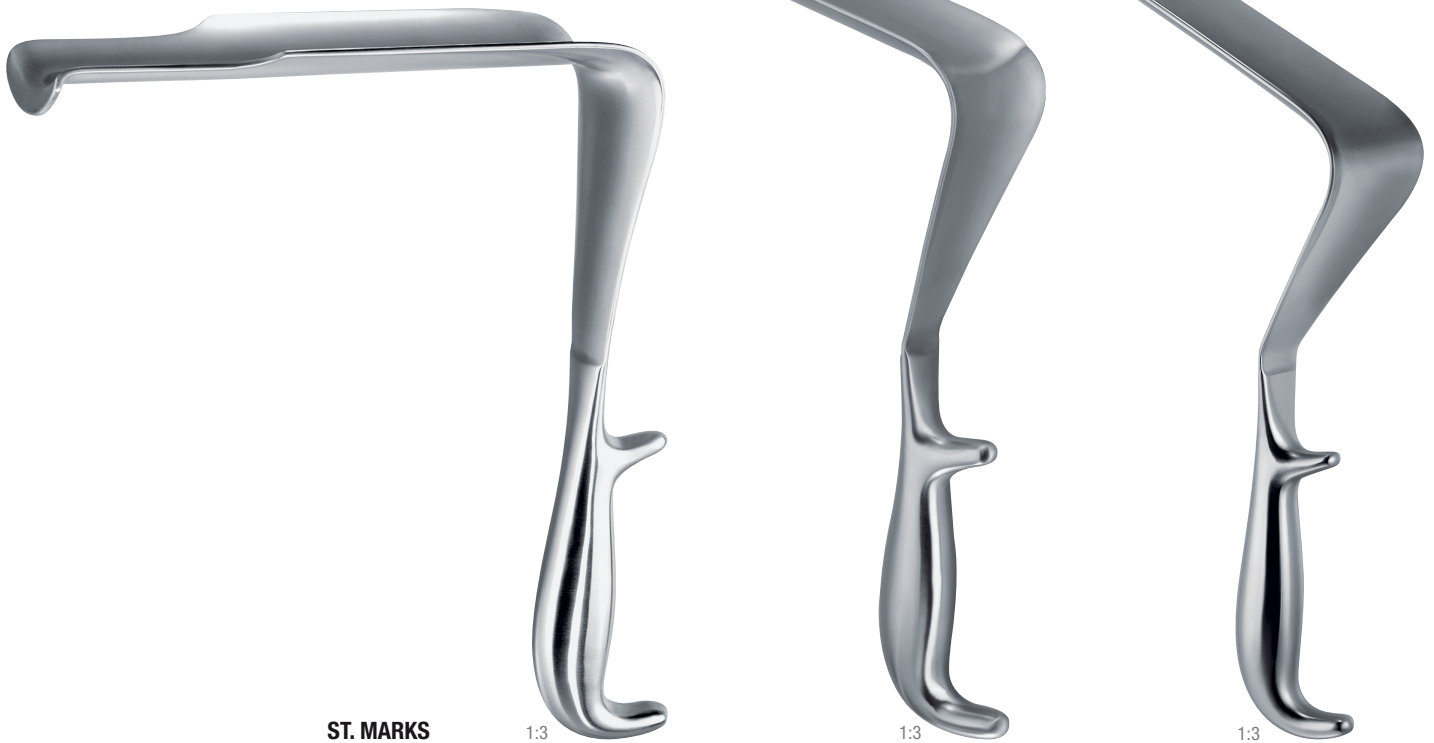

ST. MARKS

290 mm – 11½"	325 mm – 12¾"	330 mm – 13"
130 mm x 60 mm	180 mm x 60 mm	180 mm x 60 mm
415-611-020	415-611-010	415-611-030

Wundhaken Retractors



Wundhaken
Retractors
Ecarteurs
Separadores
Divaricatori

CUSHING

200 mm – 8"

318-230-200



1:2

KOERTE

280 mm – 11"

120 mm x 47 mm

415-613-280

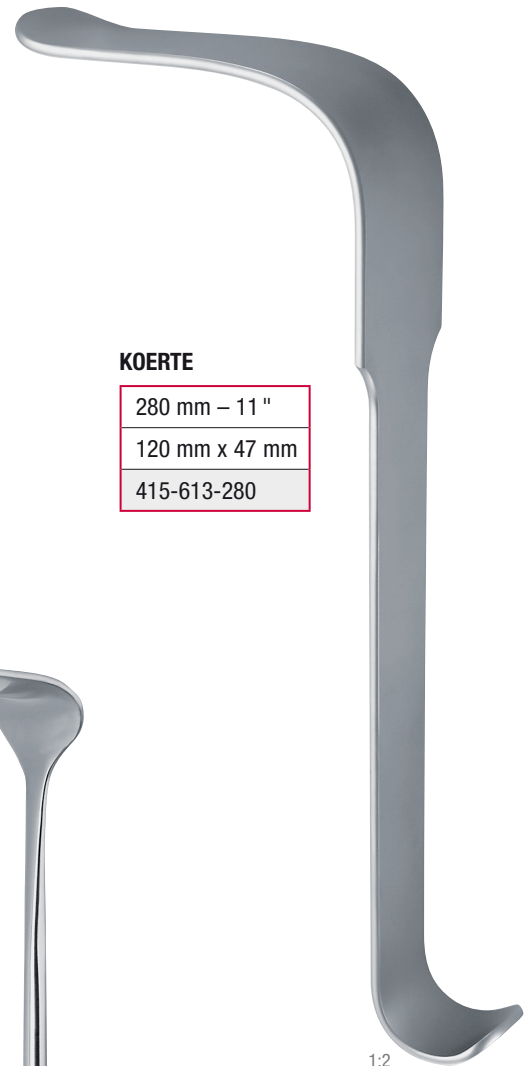

1:2

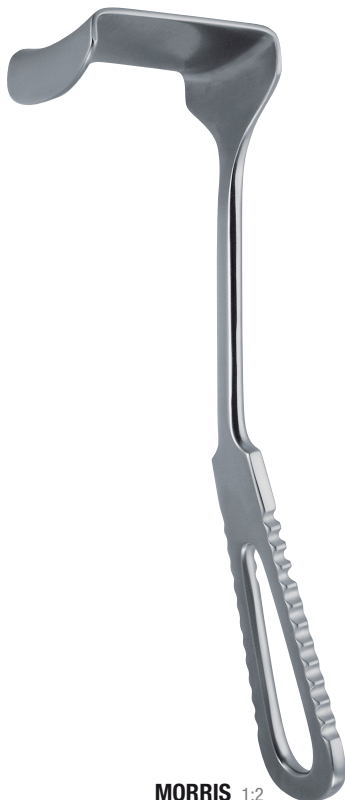

MORRIS 1:2

210 mm – 8¼"

50 mm x 55 mm

318-385-500



1:2

MORRIS

	38 mm x 51 mm	50 mm x 55 mm	64 mm x 51 mm
245 mm – 9¾"	318-386-380	318-386-510	318-386-640

Wundhaken Retractors

Wundhaken
Retractors

Ecarteurs
Separadores
Divaricatori

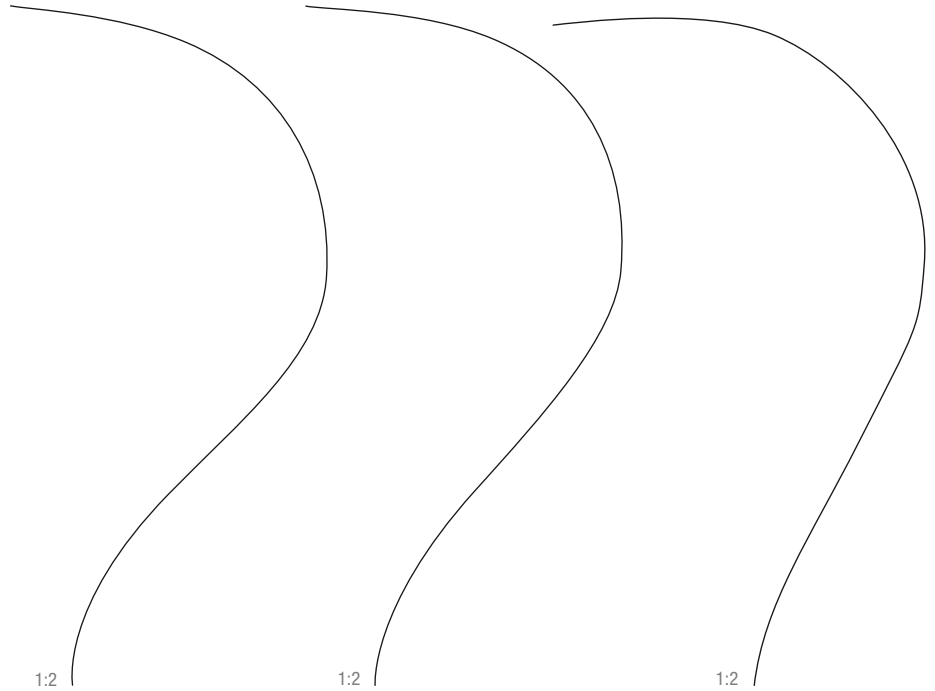

DEAVER

	x = 25 mm	x = 38 mm	x = 50 mm
315 mm – 12½"	318-185-250	318-185-380	318-185-500

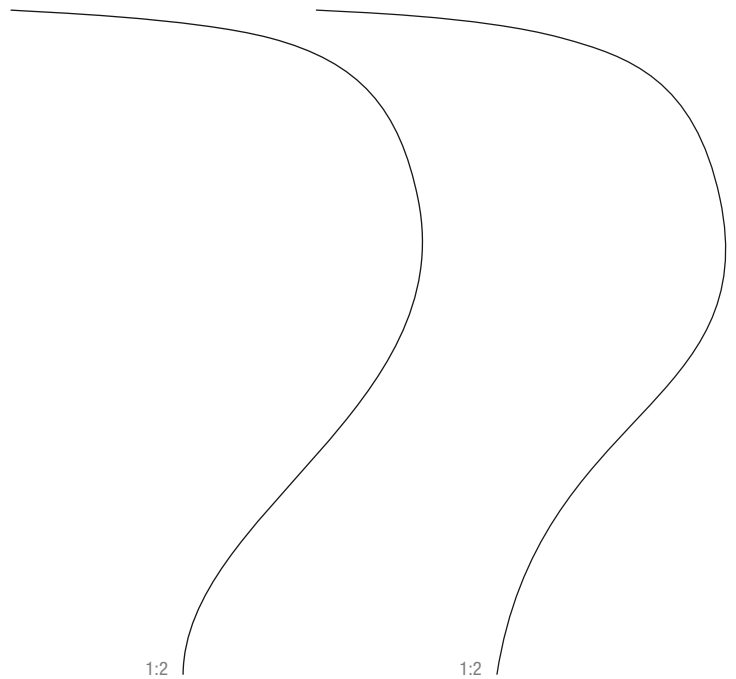

x = 75 mm	x = 100 mm
318-185-750	318-186-100

Wundhaken

Retractors



Wundhaken
Retractors
Ecarteurs
Separadores
Divaricatori



DEAVER 1:2	1:2	1:2
180 mm – 7"	215 mm – 8 ½"	230 mm – 9"
x = 19 mm	x = 22 mm	x = 25 mm
24-755-001	24-755-002	24-755-003

Wundhaken
Retractors

Ecarteurs
Separadores
Divaricatori



DEAVER

1:2

1:2

1:2

300 mm – 12"	330 mm – 13"	360 mm – 14¼"
x = 25 mm	x = 25 mm	x = 25 mm
24-755-004	24-755-005	24-755-006

Wundhaken Retractors



Wundhaken
Retractors
Ecarteurs
Separadores
Divaricatori



DEAVER 1:2

1:2

1:2

300 mm – 12"	300 mm – 12"	300 mm – 12"
x = 38 mm	x = 50 mm	x = 75 mm
24-755-007	24-755-008	24-755-009

**Wundhaken
Retractors**

*Ecarteurs
Separadores
Divaricatori*

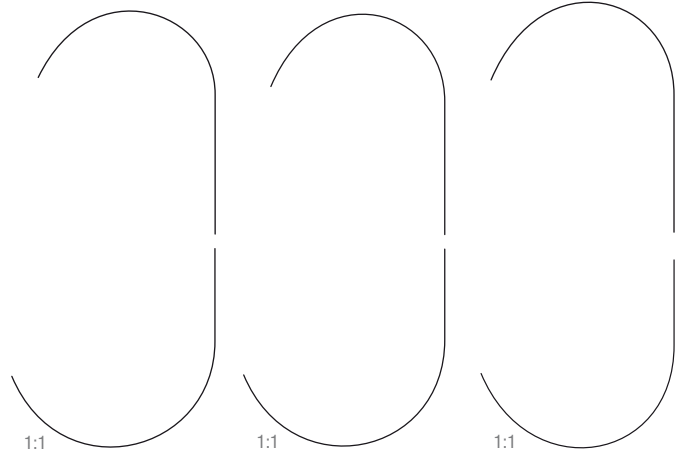

ROUX

	Fig. 1	Fig. 2	Fig. 3
	140 mm – 5½"	150 mm – 6"	170 mm – 6¾"
	24 mm x 20 mm	29 mm x 26 mm	33 mm x 29 mm
	30 mm x 28 mm	36 mm x 36 mm	38 mm x 43 mm
	24-301-001	24-301-002	24-301-003

24-301-000	x	x	x
------------	---	---	---

Satz
Set
Jeu
Juego
Serie

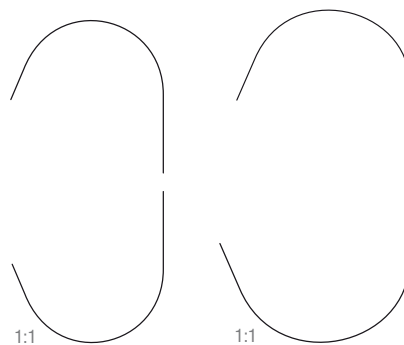

PARKER

	Fig. 1	Fig. 2
	135 mm – 5¼"	135 mm – 5¼"
	18 mm x 15 mm	22 mm x 15 mm

318-106-130	x	x
-------------	---	---

Satz
Set
Jeu
Juego
Serie

Wundhaken Retractors



Wundhaken
Retractors
Ecarteurs
Separadores
Divaricatori



1:2

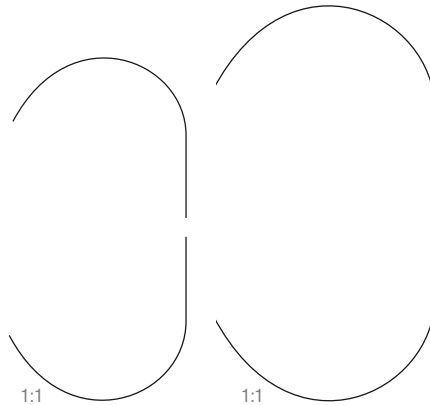

PARKER

180 mm – 7"	Fig. 1	Fig. 2
	26 mm x 25 mm	29 mm x 25 mm
	27 mm x 25 mm	27 mm x 25 mm

318-106-180	x	x
-------------	---	---

Satz
Set
Jeu
Juego
Serie



MINI-ROUX

145 mm – 5¾"
8 mm x 6 mm
318-120-150

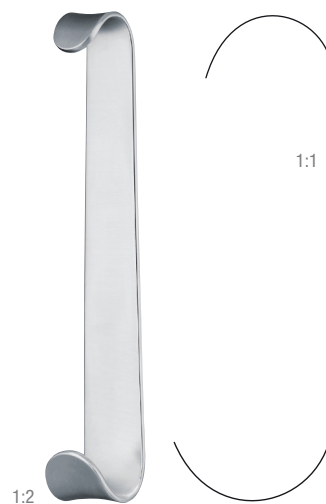

BABY-ROUX

130 mm – 5"
17 mm x 16 mm
18 mm x 22 mm
318-118-130

Wundhaken
Retractors
Ecarteurs
Separadores
Divaricatori

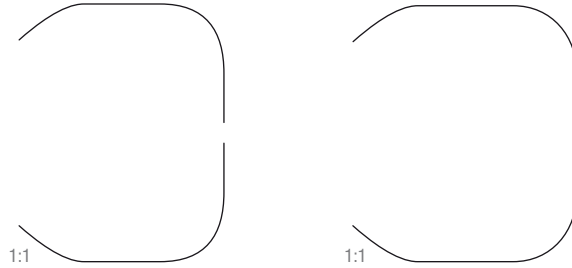

MAYO-COLLIN

150 mm – 6"	Fig. 1	Fig. 2
	25 mm x 18 mm	28 mm x 19 mm
	28 mm x 18 mm	32 mm x 19 mm

318-108-150	x	x
-------------	---	---

Satz
Set
Jeu
Juego
Serie

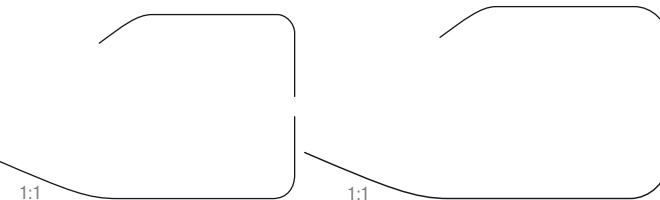

**PARKER-LANGENBECK
(US ARMY)**

210 mm – 8 ¼"	Fig. 1	Fig. 2
	21 mm x 24 mm	25 mm x 24 mm
	40 mm x 15 mm	45 mm x 15 mm

24-333-000	x	x
------------	---	---

Satz
Set
Jeu
Juego
Serie

Wundhaken

Retractors



Wundhaken
Retractors
Ecarteurs
Separadores
Divaricatori

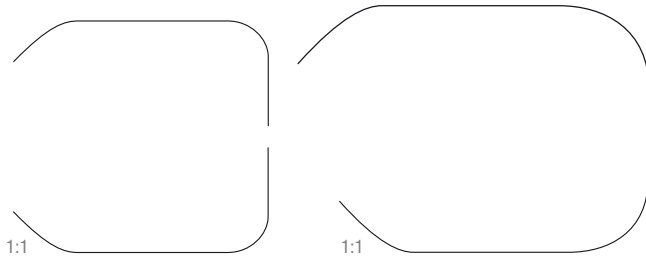

MATHIEU

200 mm – 8"	Fig. 1	Fig. 2
	42 mm x 13 mm	47 mm x 13 mm
	42 mm x 26 mm	46 mm x 26 mm
	318-130-010	318-130-020

318-130-200	x	x
-------------	---	---

Satz
 Set
 Jeu
 Juego
 Serie

Wundhaken
Retractors
Ecarteurs
Separadores
Divaricatori

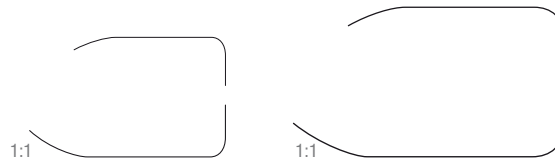

FARABEUF

120 mm – 4 3/4"	Fig. 1	Fig. 2
	26 mm x 10 mm	30 mm x 10 mm
	30 mm x 12 mm	34 mm x 12 mm

24-311-000	x	x
------------	---	---

Satz
Set
Jeu
Juego
Serie

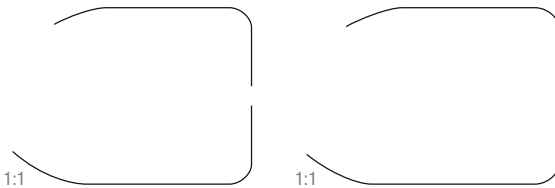

FARABEUF

150 mm – 6"	Fig. 1	Fig. 2
	23 mm x 16 mm	27 mm x 16 mm
	26 mm x 16 mm	30 mm x 16 mm

24-313-000	x	x
------------	---	---

Satz
Set
Jeu
Juego
Serie

Wundhaken

Retractors



Wundhaken
Retractors
Ecarteurs
Separadores
Divaricatori



ALM

70 mm – 2¾"	25-020-070	415-712-070	25-024-070
100 mm – 4"	25-020-100	415-712-100	25-024-100

scharf
 sharp
 pointu
 agudo
 acuto

halbscharf
 semi sharp
 semi pointu
 semi agudo
 semi acuto

stumpf
 blunt
 mousse
 romo
 smusso



BOSE

1:2

70 mm – 2¾"	354-111-070
-------------	-------------



HOLTZHEIMER 1:2

100 mm – 4"	25-026-100	25-028-100
-------------	------------	------------

scharf
 sharp
 pointu
 agudo
 acuto

stumpf
 blunt
 mousse
 romo
 smusso



JANSEN 1:2

100 mm – 4"	25-040-100	25-042-100
-------------	------------	------------

scharf
 sharp
 pointu
 agudo
 acuto

stumpf
 blunt
 mousse
 romo
 smusso

Wundsperrer

Self-retaining retractors

Ecarteurs autostatiques

Separadores autoestáticos

Divaricatori autostatici



CLOWARD-CONTOUR 1:2

140 mm – 5½"	415-721-140	415-723-140
	3 x 4 scharf sharp pointu agudo acuto	3 x 4 stumpf blunt mousse romo smusso

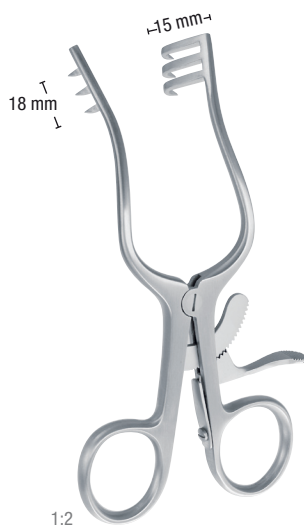

WEITLANER-WULLSTEIN 1:2

130 mm – 5"	25-091-130	25-093-130
	3 x 3 scharf sharp pointu agudo acuto	3 x 3 stumpf blunt mousse romo smusso



MILLIGAN 1:2

130 mm – 5"	415-761-130
	3 x 3 stumpf blunt mousse romo smusso

Wundhaken

Retractors



Wundsperrer

Self-retaining retractors

Ecarteurs autostatiques

Separadores autoestáticos

Divaricatori autostatici



1:2

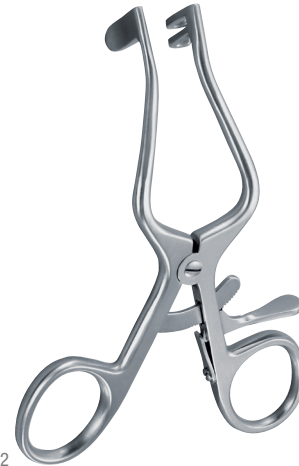

1:2

BELLUCCI

110 mm – 4 ¼ "	25-007-110	25-009-110
----------------	------------	------------

1 x 2
links, stumpf
left, blunt
gauche, mousse
izquierda, romo
sinistra, smusso

1 x 2
rechts, stumpf
right, blunt
droit, mousse
derecha, romo
destra, smusso



1:2

MOLLISON

150 mm – 6 "	318-689-150
--------------	-------------

4 x 4
scharf
sharp
pointu
agudo
acuto

Wundsperrer

Self-retaining retractors

Ecarteurs autostatiques

Separadores autoestáticos

Divaricatori autostatici

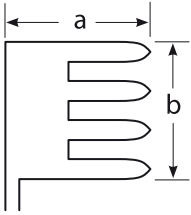

WEITLANER-LOKTITE

105 mm – 4 ¼"	a = 17 mm – b = 13 mm	25-050-105	25-051-105	25-052-105			
130 mm – 5"	a = 17 mm – b = 17 mm				25-060-130	25-061-130	25-062-130
165 mm – 6 ½"	a = 17 mm – b = 17 mm				25-064-165	25-065-165	25-066-165
200 mm – 8"	a = 20 mm – b = 19 mm				25-074-200	25-075-200	25-076-200
260 mm – 10 ¼"	a = 26 mm – b = 21 mm				415-756-260	415-755-260	415-757-260

2 x 3
scharf
sharp
pointu
agudo
acuto

2 x 3
halbscharf
semi sharp
semi pointu
semi agudo
semi acuto

2 x 3
stumpf
blunt
mousse
romo
smusso

3 x 4
scharf
sharp
pointu
agudo
acuto

3 x 4
halbscharf
semi sharp
semi pointu
semi agudo
semi acuto

3 x 4
stumpf
blunt
mousse
romo
smusso

Wundhaken

Retractors



Wundsperrer

Self-retaining retractors

Ecarteurs autostatiques

Separadores autoestáticos

Divaricatori autostatici



1:2

PLESTER

130 mm – 5"	415-751-130	415-752-130
	2 x 2 stumpf blunt mousse romo smusso	2 x 2 scharf sharp pointu agudo acuto



1:2

PLESTER



1:2

110 mm – 4 ¼"	25-011-110	25-013-110
	2 x 1 links, stumpf left, blunt gauche, mousse izquierda, romo sinistra, smusso	2 x 1 rechts, stumpf right, blunt droit, mousse derecha, romo destra, smusso

Wundsperrer

Self-retaining retractors

Ecarteurs autostatiques

Separadores autoestáticos

Divaricatori autostatici



1:2

**NORFOLK
AND NORWICH**

220 mm – 8 3/4"	318-670-220
-----------------	-------------

4 x 5
stumpf
blunt
mousse
romo
smusso



1:2

TRAVERS

215 mm – 8 1/2"	25-098-210
-----------------	------------

4 x 5
stumpf
blunt
mousse
romo
smusso



1:2

ANDERSON-ADSON

195 mm – 7 3/4"	318-676-190	318-674-200
-----------------	-------------	-------------

4 x 4
scharf
sharp
pointu
agudo
acuto

4 x 4
stumpf
blunt
mousse
romo
smusso

Wundhaken Retractors



Wundsperrer
Self-retaining retractors
Ecarteurs autostatiques
Separadores autoestáticos
Divaricatori autostatici



ADSON (CONE)

130 mm – 5"	a = 17 mm – b = 19 mm	415-766-130	415-767-130
160 mm – 6 ¼"	a = 17 mm – b = 19 mm	415-766-160	415-767-160
200 mm – 8"	a = 20 mm – b = 20 mm	415-766-200	415-767-200
260 mm – 10 ¼"	a = 26 mm – b = 21 mm	415-766-260	415-767-260

3 x 4
scharf
sharp
pointu
agudo
acuto

3 x 4
stumpf
blunt
mousse
romo
smusso



1:2

BECKMANN-EATON

320 mm – 12 ½"
25-120-320

7 x 7
scharf
sharp
pointu
agudo
acuto

Wundsperrer

Self-retaining retractors

Ecarteurs autostatiques

Separadores autoestáticos

Divaricatori autostatici

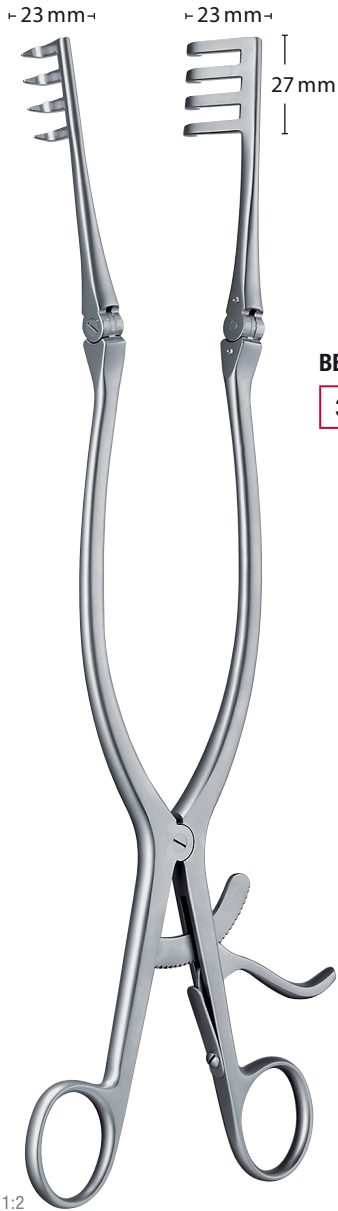

BECKMANN

310 mm – 12¼"	25-114-310	25-115-310	318-687-310
4 x 4	4 x 4	4 x 4	4 x 4
scharf	halbscharf	stumpf	
sharp	semi sharp	blunt	
pointu	semi pointu	mousse	
agudo	semi agudo	romo	
acuto	semi acuto	smusso	

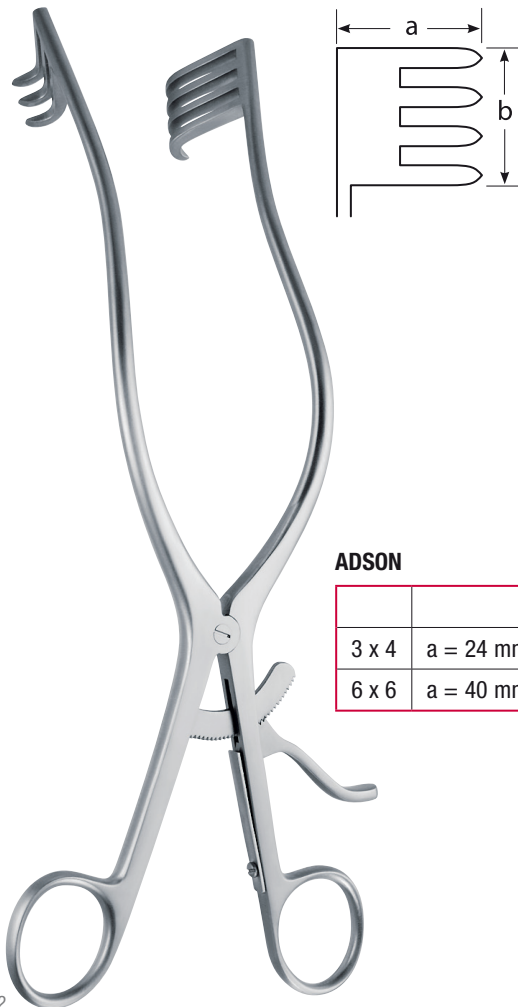

ADSON

		265 mm – 10½"	265 mm – 10½"
3 x 4	a = 24 mm – b = 24 mm	318-678-260	318-679-260
6 x 6	a = 40 mm – b = 40 mm	318-678-270	318-679-270

scharf
sharp
pointu
agudo
acuto

stumpf
blunt
mousse
romo
smusso

1:2

1:2

Wundhaken

Retractors



Wundsperrer

Self-retaining retractors

Ecarteurs autostatiques

Separadores autoestáticos

Divaricatori autostatici

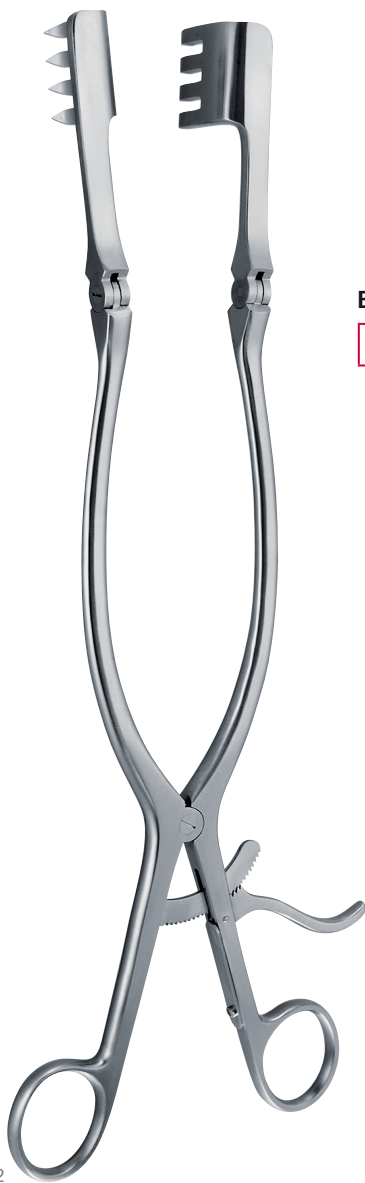

1:2

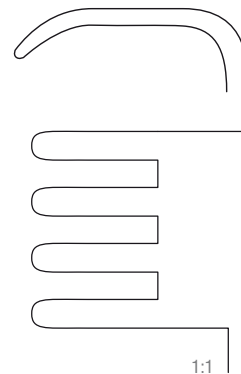

1:1

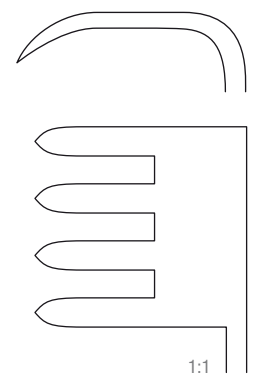

1:1

BECKMANN-ADSON

310 mm – 12 1/4"

415-774-000

415-774-010

stumpf
blunt
mousse
romo
smusso

scharf
sharp
pointu
agudo
acuto

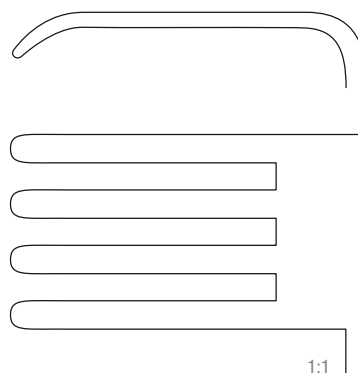

1:1

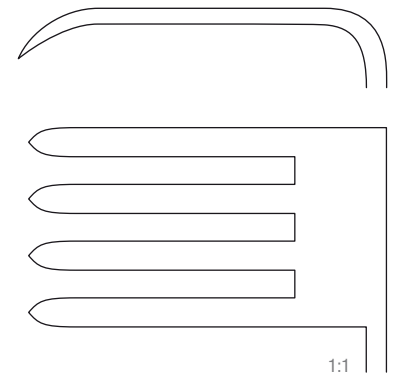

1:1

415-774-020

415-774-030

stumpf, mit tiefen Blättern
blunt, with deep blades
mousse, avec lames profondes
romo, con palas profundas
smusso, con valve profonda

scharf, mit tiefen Blättern
sharp, with deep blades
pointu, avec lames profondes
agudo, con palas profundas
acuto, con valve profonde

Wundhaken Retractors

Wundsperrer

Self-retaining retractors

Ecarteurs autostatiques

Separadores autoestáticos

Divaricatori autostatici



RIGBY 1:2

180 mm – 7"

318-802-180



GELPI-LOKTITE

1:2

90 mm – 3½"

318-798-090

110 mm – 4¼"

318-798-110

140 mm – 5½"

25-102-140

160 mm – 6⅓"

25-102-160

180 mm – 7"

25-102-180

318-800-180



1:2

**MARKHAM-
MEYERDING**

180 mm – 7"

318-708-180

318-709-180

rechts
right
droit
derecha
destra

links
left
gauche
izquierda
sinistra

Wundhaken

Retractors



Wundsperrer
Self-retaining retractors
Ecarteurs autostatiques
Separadores autoestáticos
Divaricatori autostatici



1:2

HENLEY

165 mm – 6 ½"	415-765-000	415-764-000
---------------	-------------	-------------

3 x 4
scharf
 sharp
 pointu
 agudo
 acuto

3 x 4
stumpf
 blunt
 mousse
 romo
 smusso

komplett mit 3 Mittelvalven
 complete with 3 center blades
 complet avec 3 valves centrales
 completa con 3 valvas centrales
 completo con 3 valve centrali



19 mm x 16 mm	25 mm x 16 mm	32 mm x 16 mm
415-764-190	415-764-250	415-764-320

Mittelvalven
 Center blades
 Valves centrales
 Valvas centrales
 Valve centrali

Bauchdeckenhalter
Abdominal retractors

Ecarteurs abdominaux
Separadores abdominales
Divaricatori addominali

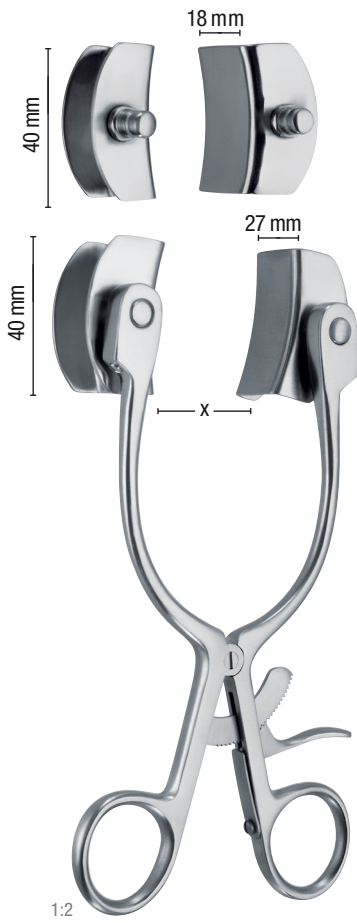

BABY-COLLIN

180 mm – 7"		
x = 80 mm		
415-816-000	40 mm x 18 mm	40 mm x 27 mm

komplett mit 2 Paar Valven
complete with 2 pairs of blades
complet avec 2 paires de valves
completo con 2 pares de valvas
completo con 2 paia di valve



COLLIN 1:2

220 mm – 8¾"	x = 100 mm	318-806-220
--------------	------------	-------------



COLLIN

225 mm – 8¾"		
x = 100 mm		
25-530-000	a = 38 mm – b = 55 mm	a = 38 mm – b = 55 mm
25-534-000	a = 38 mm – b = 80 mm	a = 50 mm – b = 75 mm

komplett mit
complete with
complet avec
completo con
completo con

Seitenvalven
Lateral blades
Valves latérales
Valvas laterales
Valve laterali

Mittelvalve
Center blade
Valve centrale
Valva central
Valva centrale

Wundhaken Retractors



Bauchdeckenhalter Abdominal retractors

*Ecarteurs abdominaux
Separadores abdominales
Divaricatori addominali*



COLLIN 1:2

260 mm – 10 ½"		
x = 160 mm		
25-538-000	60 mm x 80 mm	60 mm x 75 mm

komplett mit
complete with
complet avec
completo con
completo con

Seitenvalven
Lateral blades
Valves latérales
Valvas laterales
Valve laterali

Mittelvalve
Center blade
Valve centrale
Valva central
Valva centrale

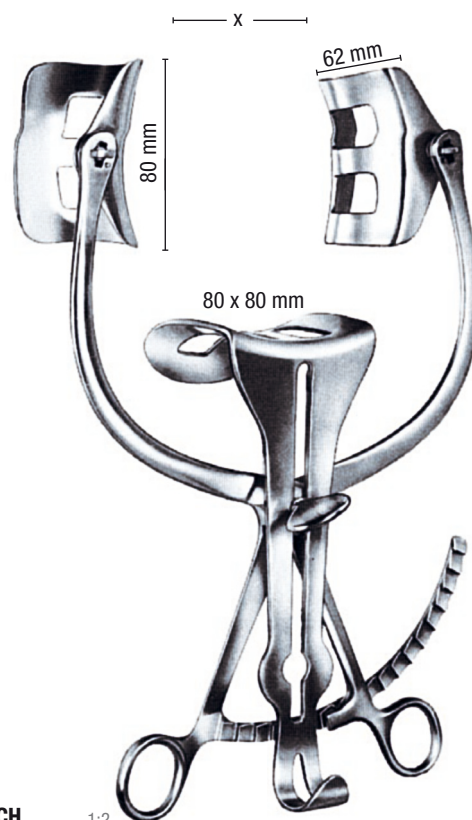

HOLZBACH 1:2

260 mm – 10 ¼"		
x = 100 mm		
318-816-000	62 mm x 80 mm	80 mm x 80 mm

komplett mit
complete with
complet avec
completo con
completo con

Seitenvalven
Lateral blades
Valves latérales
Valvas laterales
Valve laterali

Mittelvalve
Center blade
Valve centrale
Valva central
Valva centrale

Bauchdeckenhalter
Abdominal retractors

Ecarteurs abdominaux
Separadores abdominales
Divaricatori addominali

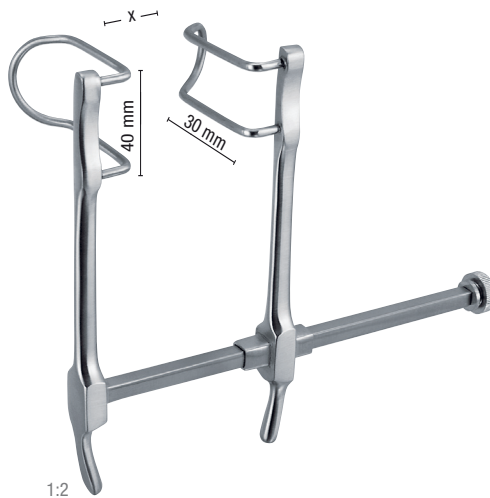

GOSSET

1:2

125 mm – 5"	x = 100 mm	415-836-000
-------------	------------	-------------

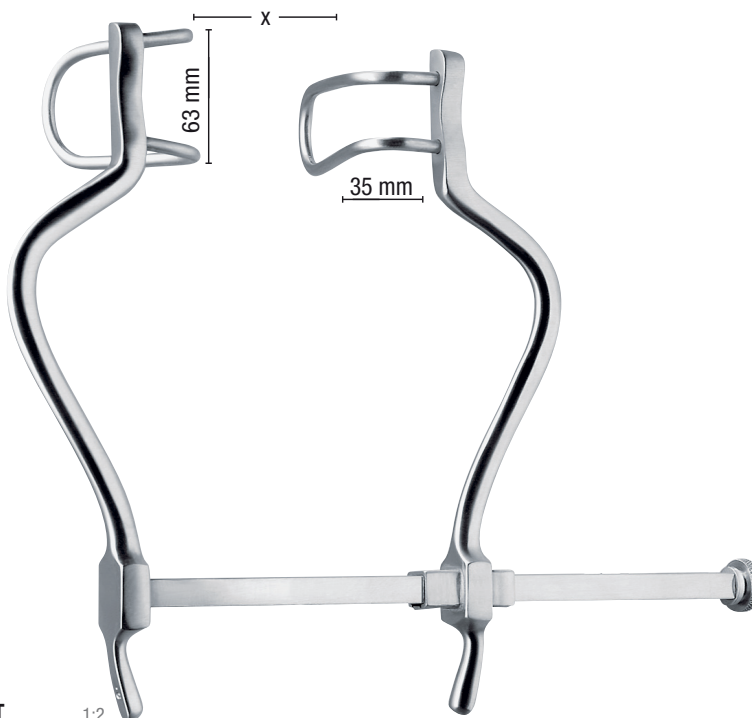

GOSSET

1:2

185 mm – 7 ¼"	x = 140 mm	25-554-000
---------------	------------	------------

Wundhaken Retractors



Bauchdeckenhalter Abdominal retractors

*Ecarteurs abdominaux
Separadores abdominales
Divaricatori addominali*

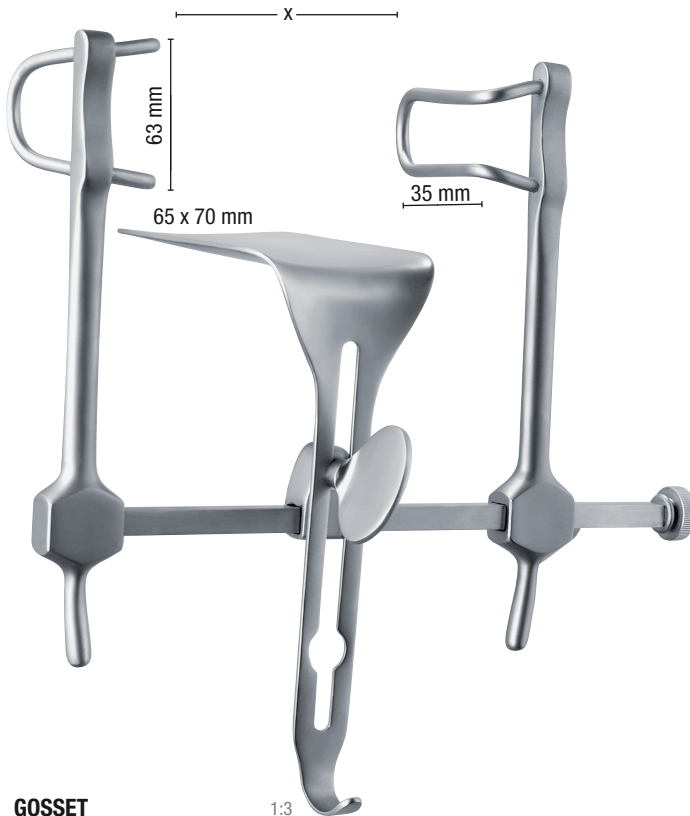

GOSSET

1:3

x = 160 mm		
318-758-160	35 mm x 63 mm	65 mm x 70 mm

komplett mit
complete with
complet avec
completo con
completo con

Seitenvalven
Lateral blades
Valves latérales
Valvas laterales
Valve laterali

Mittelvalve
Center blade
Valve centrale
Valva central
Valva centrale



BALFOUR

1:3

x = 200 mm		
25-578-000	35 mm x 100 mm	70 mm x 100 mm

komplett mit
complete with
complet avec
completo con
completo con

Seitenvalven
Lateral blades
Valves latérales
Valvas laterales
Valve laterali

Mittelvalve
Center blade
Valve centrale
Valva central
Valva centrale

Bauchdeckenhalter
Abdominal retractors

Ecarteurs abdominaux
Separadores abdominales
Divaricatori addominali



BALFOUR

x = 180 mm		
25-574-000	35 mm x 70 mm	45 mm x 80 mm

komplett mit
complete with
complet avec
completo con
completo con

Seitenvalven
Lateral blades
Valves latérales
Valvas laterales
Valve laterali

Mittelvalve
Center blade
Valve centrale
Valva central
Valva centrale

x = 250 mm		
318-760-250	35 mm x 100 mm	70 mm x 85 mm

komplett mit
complete with
complet avec
completo con
completo con

Seitenvalven
Lateral blades
Valves latérales
Valvas laterales
Valve laterali

Mittelvalve
Center blade
Valve centrale
Valva central
Valva centrale

45 mm x 80 mm	318-761-450
70 mm x 85 mm	318-761-700
80 mm x 90 mm	318-761-800

Mittelvalven, allein
Center blades, only
Valves centrales, seul
Valvas centrales, sola
Valve centrali, solo



BALFOUR-BABY

x = 90 mm		
25-570-000	27 mm x 27 mm	20 mm x 24 mm

komplett mit
complete with
complet avec
completo con
completo con

Seitenvalven
Lateral blades
Valves latérales
Valvas laterales
Valve laterali

Mittelvalve
Center blade
Valve centrale
Valva central
Valva centrale

Wundhaken Retractors



Bauchdeckenhalter Abdominal retractors

*Ecarteurs abdominaux
Separadores abdominales
Divaricatori addominali*



1:3

RICARD

318-818-280	60 mm x 80 mm	55 mm x 70 mm
-------------	---------------	---------------

komplett mit
complete with
complet avec
completo con
completo con

Seitenvalven
Lateral blades
Valves latérales
Valvas laterales
Valve laterali

Mittelvalve
Center blade
Valve centrale
Valva central
Valva centrale

318-818-300	70 mm x 85 mm	80 mm x 90 mm
-------------	---------------	---------------

komplett mit
complete with
complet avec
completo con
completo con

Seitenvalven
Lateral blades
Valves latérales
Valvas laterales
Valve laterali

Mittelvalve
Center blade
Valve centrale
Valva central
Valva centrale



1:3

O'SULLIVAN- O'CONNOR

318-750-000	45 mm x 90 mm	70 mm x 100 mm
-------------	---------------	----------------

komplett mit
complete with
complet avec
completo con
completo con

Seitenvalven
Lateral blades
Valves latérales
Valvas laterales
Valve laterali

Mittelvalve
Center blade
Valve centrale
Valva central
Valva centrale

Bauchdeckenhalter
Abdominal retractors

Ecarteurs abdominaux
Separadores abdominales
Divaricatori addominali

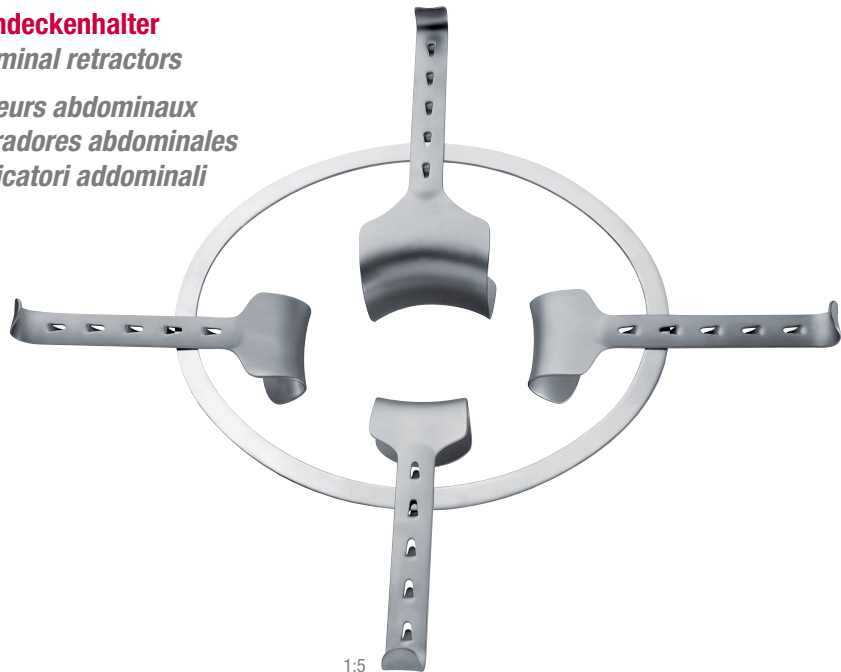

KIRSCHNER, OVAL

1:5

240 mm x 300 mm	50 mm x 65 mm	80 mm x 90 mm	50 mm x 98 mm	35 mm x 105 mm
25-604-300	25-592-050	25-605-080	25-605-098	25-605-105

1 Rahmen	3 Valven	1 Valve	1 Valve	1 Valve
1 Frame	3 Blades	1 Blade	1 Blade	1 Blade
1 Cadre	3 Valves	1 Valve	1 Valve	1 Valve
1 Cuadro	3 Valvas	1 Valva	1 Valva	1 Valva
1 Quadro	3 Valve	1 Valva	1 Valva	1 Valva

25-600-000	x	x	x	x	x
------------	---	---	---	---	---

Satz
Set
Jeu
Juego
Serie

KIRSCHNER

240 mm x 240 mm	40 mm x 55 mm	50 mm x 65 mm
25-586-000	25-592-040	25-592-050

1 Rahmen, fest	2 Valven	2 Valven
1 Frame, rigid	2 Blades	2 Blades
1 Cadre, rigide	2 Valves	2 Valves
1 Cuadro, rigido	2 Valvas	2 Valvas
1 Quadro, rigido	2 Valve	2 Valve

25-584-000	x	x	x
------------	---	---	---

Satz
Set
Jeu
Juego
Serie

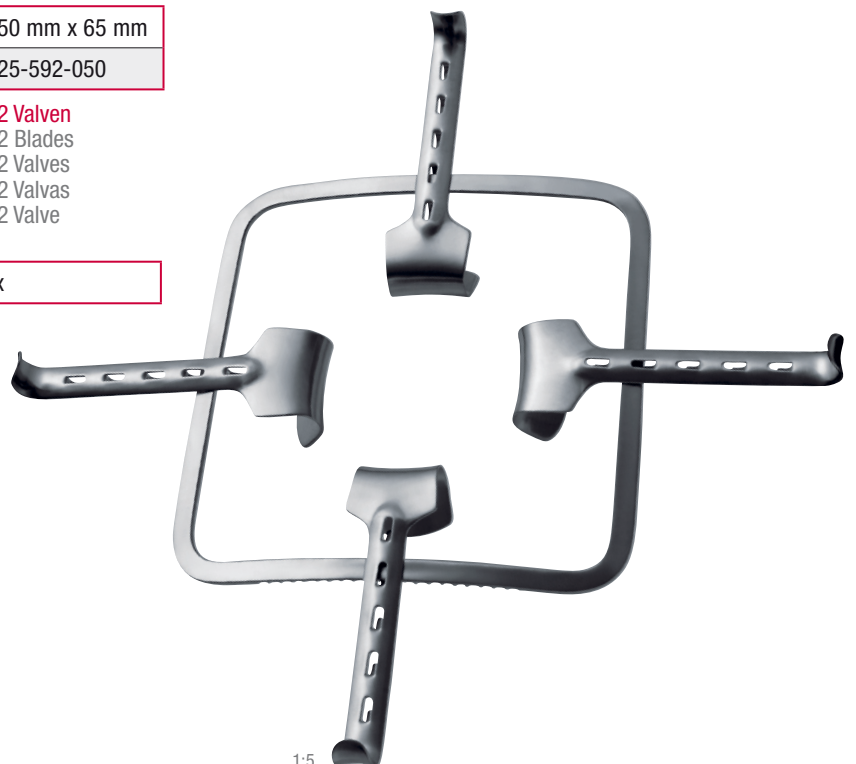

1:5

Wundhaken

Retractors



Bauchdeckenhalter

Abdominal retractors

Ecarteurs abdominaux
Separadores abdominales
Divaricatori addominali



Rahmen zusammenlegbar
 Frame foldable
 Cadre pliant
 Cuadro plegable
 Quadro piegabile

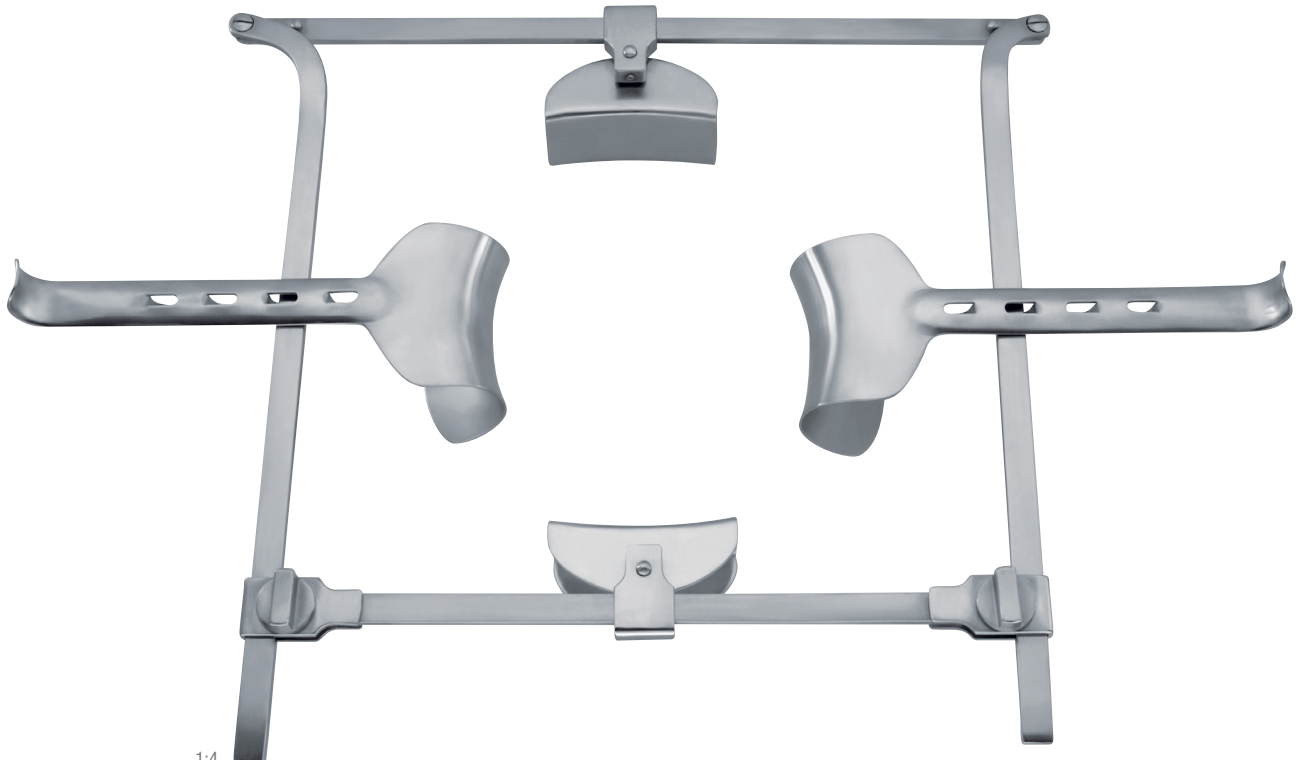

1:4

FRANZ

300 mm x 300 mm	40 mm x 60 mm	45 mm x 80 mm	50 mm x 65 mm	60 mm x 85 mm
415-890-300	415-835-380	415-835-450	25-592-050	415-885-600

1 Rahmen, zusammenlegbar	2 Valven	2 Valven	2 Valven	2 Valven
1 Frame, foldable	2 Blades	2 Blades	2 Blades	2 Blades
1 Cadre pliant	2 Valves	2 Valves	2 Valves	2 Valves
1 Cuadro plegable	2 Valvas	2 Valvas	2 Valvas	2 Valvas
1 Quadro piegabile	2 Valve	2 Valve	2 Valve	2 Valve

415-890-000	x	x		x	
415-892-000	x	x	x	x	x

Satz
 Set
 Jeu
 Juego
 Serie

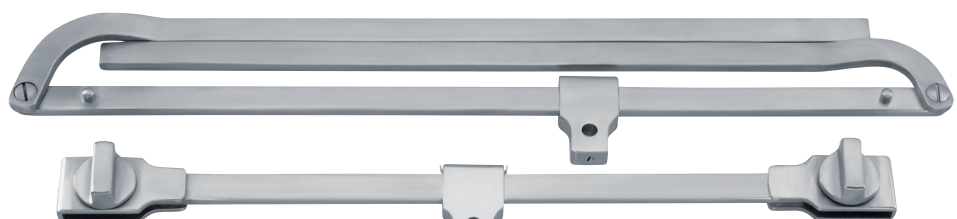

1:4

Bauchdeckenhalter
Abdominal retractors

Ecarteurs abdominaux
Separadores abdominales
Divaricatori addominali



Valven für Kirschner- und Franz-Rahmen
Blades for Kirschner- and Franz-frames
Valves pour cadres Kirschner et Franz
Valvas para los cuadros de Kirschner y Franz
Valve per i quadri di Kirschner e Franz

1:3



1:3



1:3



1:3



40 mm x 60 mm	45 mm x 80 mm	40 mm x 55 mm	50 mm x 65 mm
415-835-380	415-835-450	25-592-040	25-592-050

1:3



1:3



1:3



1:3



60 mm x 85 mm	80 mm x 90 mm	50 mm x 98 mm	35 mm x 105 mm
415-885-600	25-605-080	25-605-098	25-605-105

Wundhaken

Retractors



Bauchspatel

Abdominal spatula

Spatula abdominales

Espátulas abdominales

Spatole addominali



RIBBON

	19 mm	25 mm	30 mm	40 mm	50 mm
330 mm – 13"	318-166-190	318-166-250	318-166-320	318-166-400	318-166-500

biegsam
malleable
malléable
maleable
flessibile



RIBBON

	6 mm	9 mm	12 mm	17 mm	20 mm
200 mm – 8"	318-164-060	318-164-090	318-164-120	318-164-170	318-164-200

weich
soft
souple
flexible
morbido

	25 mm
250 mm – 9¾"	318-164-250

weich
soft
souple
flexible
morbido

	6,5 mm	9,5 mm	13 mm	16 mm	19 mm	25 mm
200 mm – 8"	415-971-060	415-971-090	415-971-130	415-971-160	415-971-190	415-971-250

biegsam, sehr weich
malleable, very soft
malléable, très souple
maleable, muy flexible
flessibile, molto morbido

Bauchspatel

Abdominal spatula

Spatula abdominales

Espátulas abdominales

Spatole addominali



HABERER

200 mm – 8"	280 mm – 11"	300 mm – 12"
17 mm x 25 mm	25 mm x 30 mm	37 mm x 45 mm
318-170-170	318-170-250	318-170-370

biegsam
malleable
malléable
maleable
flessibile



REVERDIN

280 mm – 11"	46 mm x 60 mm	318-171-280
--------------	---------------	-------------

Wundhaken

Retractors



Wundspreizer
Retractors
Ecarteurs
Separadores
Divaricatori

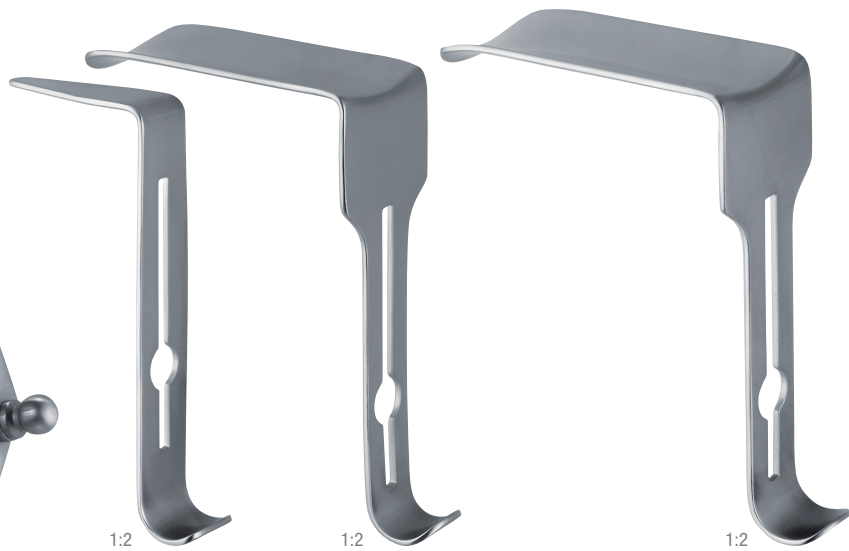

O'SULLIVAN-O'CONNOR

Fig. 1	Fig. 2	Fig. 3	Set
45 mm x 17 mm	90 mm x 37 mm	90 mm x 45 mm	Fig. 1, 2, 3
62-293-001	62-293-002	62-293-003	62-290-000

komplett
complete
complet
completo
completo



FRIEDMANN

100 mm – 4"	370-347-100
-------------	-------------

Laminektomiesperrer
Laminectomy retractors

Ecarteurs pour laminectomie
Separadores para laminectomía
Divaricatori per laminectomia



CLOWARD

160 mm – 6 ¼"	250 mm – 9 ¾"
318-707-000	318-706-000

komplett mit je 2 Valven Fig. 1 - Fig. 5
complete with 2 blades ea. Fig. 1 - Fig. 5
complet avec 2 valves chacune Fig. 1 - Fig. 5
completo con 2 valvas de cada Fig. 1 - Fig. 5
completo con 2 valve Fig. 1 - Fig. 5

komplett mit je 2 Valven Fig. 1 - Fig. 5
complete with 2 blades ea. Fig. 1 - Fig. 5
complet avec 2 valves chacune Fig. 1 - Fig. 5
completo con 2 valvas de cada Fig. 1 - Fig. 5
completo con 2 valve Fig. 1 - Fig. 5

318-707-010	318-706-010
-------------	-------------

Sperrer ohne Valven
Retractor without blades
Ecarteur sans valves
Separador sin valvas
Divaricatore senza valve

Sperrer ohne Valven
Retractor without blades
Ecarteur sans valves
Separador sin valvas
Divaricatore senza valve

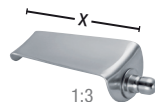

x = 40 mm	318-707-400
x = 45 mm	318-707-450
x = 50 mm	318-707-500
x = 55 mm	318-707-550
x = 60 mm	318-707-600

stumpf
blunt
mousse
romo
smusso

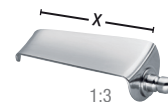

x = 40 mm	318-706-400
x = 45 mm	318-706-450
x = 50 mm	318-706-500
x = 55 mm	318-706-550
x = 60 mm	318-706-600

gezahnt
toothed
dentelée
dentada
dentata

Wundhaken

Retractors



Laminektomiesperrer

Laminectomy retractors

Ecarteurs pour laminectomie

Separadores para laminectomía

Divaricatori per laminectomia



165 mm – 6 1/2 "	270 mm – 10 3/4 "
340-401-170	340-401-270

CLOWARD- VERTREBRA



160 mm – 6 1/4 "	340-397-160
------------------	-------------

Wundhaken Retractors

Laminektomiesperrer

Laminectomy retractors

Ecarteurs pour laminectomie

Separadores para laminectomía

Divaricatori per laminectomia

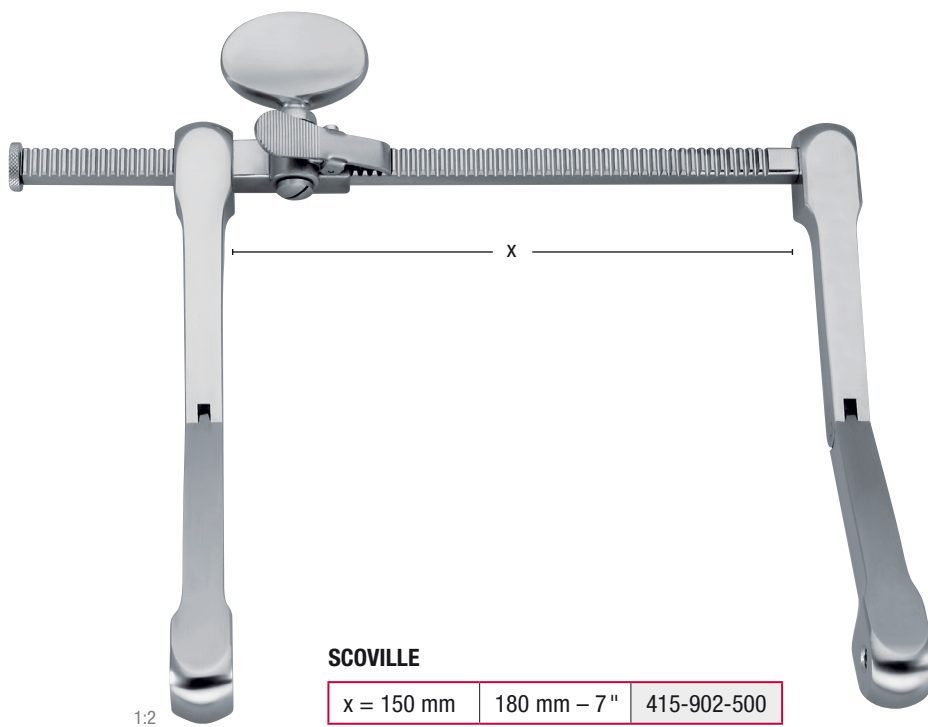
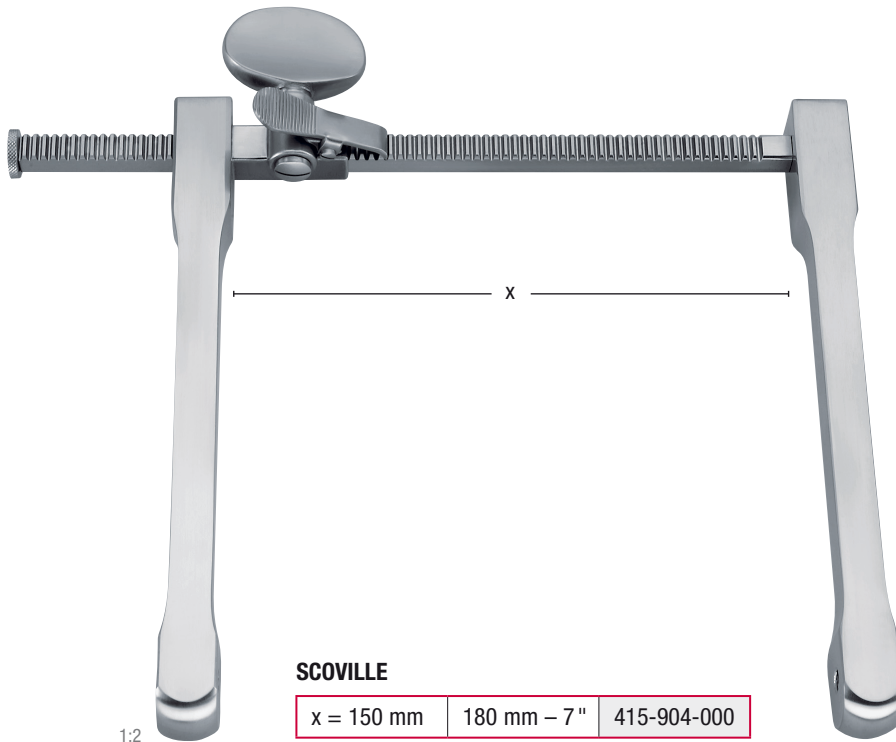

Wundhaken Retractors



Laminektomiesperrer

Laminectomy retractors

Ecarteurs pour laminectomie

Separadores para laminectomía

Divaricatori per laminectomia

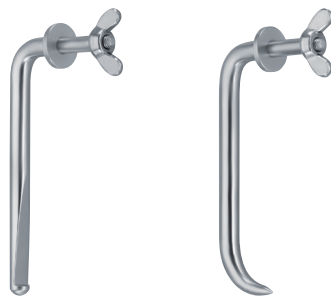
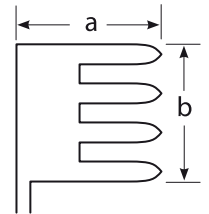

SCOVILLE

50 mm – 2"	415-902-010	415-902-060
70 mm – 2 3/4"	415-902-020	415-902-070

stumpf
blunt
mousse
romo
smusso

spitz
sharp
pointu
aguda
acuta



TAYLOR

a = 48 mm – b = 50 mm – 2" x 2"	415-902-410
a = 63 mm – b = 50 mm – 2 1/2" x 2"	415-902-420
a = 64 mm – b = 64 mm – 3 1/4" x 2 1/4"	415-902-430
a = 80 mm – b = 57 mm – 3" x 2"	415-902-440



SCOVILLE

a = 40 mm – b = 37 mm – 1 1/2" x 1 1/2"	415-902-460
a = 65 mm – b = 44 mm – 2 1/2" x 1 3/4"	415-902-470



TAYLOR

a = 75 mm – b = 32 mm – 3" x 1 1/4"	415-902-532
a = 100 mm – b = 42 mm – 4" x 1 2/3"	415-902-542

Laminektomiesperrer

Laminectomy retractors

Ecarteurs pour laminectomie

Separadores para laminectomía

Divaricatori per laminectomia

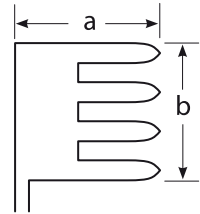

MEYERDING

a = 57 mm – b = 25 mm – 2¼" x 1"	415-902-557
a = 76 mm – b = 25 mm – 3" x 1"	415-902-576
a = 88 mm – b = 51 mm – 3½" x 2"	415-902-588



SCOVILLE

a = 64 mm – b = 25 mm – 2½" x 1"	415-902-110
a = 64 mm – b = 50 mm – 2½" x 2"	415-902-120
a = 88 mm – b = 25 mm – 3½" x 1"	415-902-130



EPSTEIN

1:2

a = 56 mm – b = 25 mm – 2¼" x 1"	415-902-656
----------------------------------	-------------



HIBBS

a = 50 mm – b = 20 mm – 2" x ¾"	415-903-001
a = 50 mm – b = 25 mm – 2" x 1"	415-903-002
a = 50 mm – b = 50 mm – 2" x 2"	415-903-003
a = 63 mm – b = 25 mm – 2½" x 1"	415-903-004
a = 63 mm – b = 37 mm – 2½" x 1½"	415-903-005
a = 76 mm – b = 25 mm – 3" x 1"	415-903-006
a = 76 mm – b = 38 mm – 3" x 1½"	415-903-007
a = 76 mm – b = 50 mm – 3" x 2"	415-903-008
a = 76 mm – b = 63 mm – 3" x 2½"	415-903-009
a = 90 mm – b = 25 mm – 3½" x 1"	415-903-010
a = 90 mm – b = 37 mm – 3½" x 1½"	415-903-011
a = 102 mm – b = 25 mm – 4" x 1"	415-903-012
a = 102 mm – b = 50 mm – 4" x 2"	415-903-013

Wundhaken Retractors



Laminektomiesperrer Laminectomy retractors

*Ecarteurs pour laminectomie
Separadores para laminectomía
Divaricatori per laminectomia*

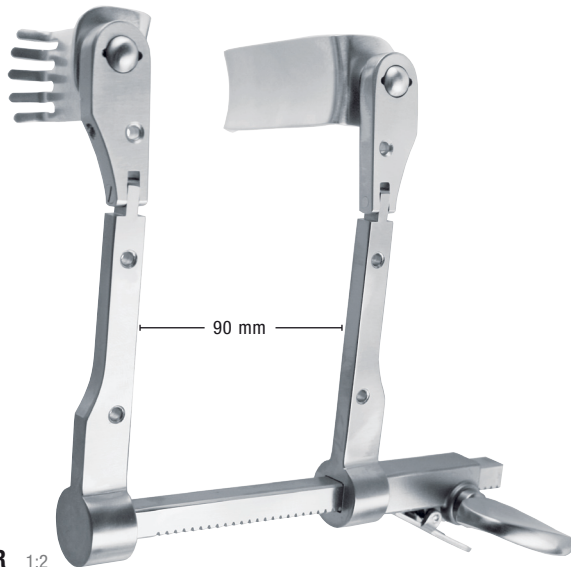

CASPAR 1:2



1:2

318-719-000	318-721-000
-------------	-------------

**komplett mit 5 medial Valven 318-714-400 – 318-714-600
und mit 5 lateral Valven 318-715-400 – 318-715-600**
complete with 5 medial blades 318-714-400 – 318-714-600
and with 5 lateral blades 318-715-400 – 318-715-600
complet avec 5 valves médianes 318-714-400 – 318-714-600
et avec 5 valves latérales 318-715-400 – 318-715-600
completo con 5 valvas mediales 318-714-400 – 318-714-600
y con 5 valvas laterales 318-715-400 – 318-715-600
completo con 5 valve mediali 318-714-400 – 318-714-600
e con 5 valve laterali 318-715-400 – 318-715-600

komplett mit 5 Valven 318-712-450 – 318-712-650
complete with 5 blades 318-712-450 – 318-712-650
complet avec 5 valves 318-712-450 – 318-712-650
completo con 5 valvas 318-712-450 – 318-712-650
completo con 5 valve 318-712-450 – 318-712-650

318-719-120	318-721-110
-------------	-------------

Sperrer ohne Valven
Retractor without blades
Ecarteur sans valves
Separador sin valvas
Divaricatore senza valve

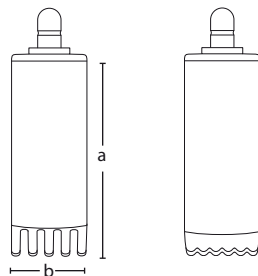

CASPAR

	medial	lateral
a = 40 mm – b = 23 mm	318-714-400	318-715-400
a = 45 mm – b = 23 mm	318-714-450	318-715-450
a = 50 mm – b = 23 mm	318-714-500	318-715-500
a = 55 mm – b = 23 mm	318-714-550	318-715-550
a = 60 mm – b = 23 mm	318-714-600	318-715-600

Sperrer ohne Valven
Retractor without blades
Ecarteur sans valves
Separador sin valvas
Divaricatore senza valve



CASPAR

a = 45 mm – b = 23 mm	318-712-450
a = 50 mm – b = 23 mm	318-712-500
a = 55 mm – b = 23 mm	318-712-550
a = 60 mm – b = 23 mm	318-712-600
a = 65 mm – b = 23 mm	318-712-650

stumpf
blunt
mousse
romo
smusso

Laminektomiesperrer

Laminectomy retractors

Ecarteurs pour laminectomie

Separadores para laminectomía

Divaricatori per laminectomia



CASPAR

318-729-001

komplett mit 5 Valven 318-712-450 – 318-712-650
complete with 5 blades 318-712-450 – 318-712-650
complet avec 5 valves 318-712-450 – 318-712-650
completo con 5 valvas 318-712-450 – 318-712-650
completo con 5 valve 318-712-450 – 318-712-650

318-729-002

Sperrer ohne Valven

Retractor without blades
Ecarteur sans valves
Separador sin valvas
Divaricatore senza valve



318-729-012

Schlüssel

Key
Clé
Llave
Chiave

Wundhaken

Retractors



Laminektomiesperrer

Laminectomy retractors

Ecarteurs pour laminectomie

Separadores para laminectomía

Divaricatori per laminectomia



CASPAR

1:1

1:1

38 mm	58 mm
318-727-500	318-727-700

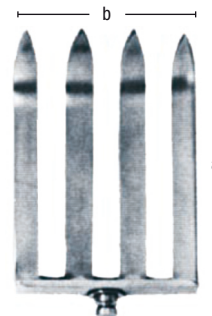
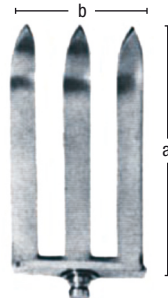
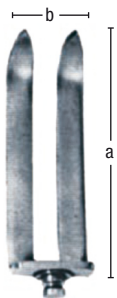

a = 35 mm – b = 22 mm	318-728-350
a = 40 mm – b = 22 mm	318-728-400
a = 45 mm – b = 22 mm	318-728-450
a = 50 mm – b = 22 mm	318-728-500
a = 55 mm – b = 22 mm	318-728-550
a = 60 mm – b = 22 mm	318-728-600
a = 65 mm – b = 22 mm	318-728-650
a = 70 mm – b = 22 mm	318-728-700

a = 35 mm – b = 37 mm	318-729-350
a = 40 mm – b = 37 mm	318-729-400
a = 45 mm – b = 37 mm	318-729-450
a = 50 mm – b = 37 mm	318-729-500
a = 55 mm – b = 37 mm	318-729-550
a = 60 mm – b = 37 mm	318-729-600
a = 65 mm – b = 37 mm	318-729-650
a = 70 mm – b = 37 mm	318-729-700

a = 35 mm – b = 52 mm	318-730-350
a = 40 mm – b = 52 mm	318-730-400
a = 45 mm – b = 52 mm	318-730-450
a = 50 mm – b = 52 mm	318-730-500
a = 55 mm – b = 52 mm	318-730-550
a = 60 mm – b = 52 mm	318-730-600
a = 65 mm – b = 52 mm	318-730-650
a = 70 mm – b = 52 mm	318-730-700

Wundhaken Retractors

Wundspreizer zur Mikrodiskektomie

Retractors for Micro-Lumbar Discectomy

Retracteurs pour la micro discectomie lumbaire

Retractor para la micro discectomía lumbar

Divaricatore per la micro dissezione lombare



CASPAR 1:2

a = 40 mm	318-744-400
a = 45 mm	318-744-450
a = 50 mm	318-744-500
a = 55 mm	318-744-550
a = 60 mm	318-744-600
a = 65 mm	318-744-650
a = 75 mm	318-744-750
a = 85 mm	318-744-850



Mit schwarzer Oberfläche

With black finish
Avec finition noir
Con color negro
Con superficie nera

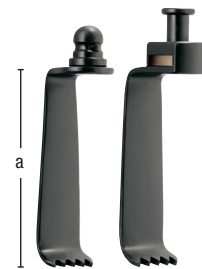

CASPAR

a = 35 mm	318-734-350	
a = 40 mm	318-734-400	318-741-400
a = 45 mm	318-734-450	318-741-450
a = 50 mm	318-734-500	318-741-500
a = 55 mm	318-734-550	318-741-550
a = 60 mm	318-734-600	318-741-600
a = 65 mm	318-734-650	318-741-650
a = 70 mm		318-741-700
a = 75 mm	318-734-750	
a = 85 mm	318-734-850	



Mit schwarzer Oberfläche

With black finish
Avec finition noir
Con color negro
Con superficie nera



CASPAR

318-734-010

1:2

Wundhaken Retractors



08

Hypophysenspekulum
Speculum for hypophysectomy
Spéculum pour hypophysectomie
Espéculo para hipofisectomía
Specolo per ipofisectomia



Mit schwarzer Oberfläche
With black finish
Avec finission noir
Con color negro
Con superficie nera



x = 70 mm	340-797-700
x = 90 mm	340-797-900
x = 110 mm	340-798-100

Spekulum für trans-sphenoidale Hypophysectomie
Speculum for trans-sphenoidal hypophysectomy
Spéculum pour hypophysectomie trans-sphenoidable
Espéculo para hipofisectomía transfenoidal
Specolo per ipofisectomia trans-sfenoidale

