

04

Arterienklemmen

Haemostatic forceps

Pinces hémostatiques

Pinzas hemostáticas

Pinze emostatiche



Arterienklemmen

Haemostatic forceps



04

Gefäßklemmen

Haemostatic forceps

Serre-fines
Serrafinas
Serrafine



DIEFFENBACH

35 mm – 1 ½ "	13-320-035	13-321-035
50 mm – 2 "	13-320-050	13-321-050
60 mm – 2 ¼ "	13-320-060	13-321-060

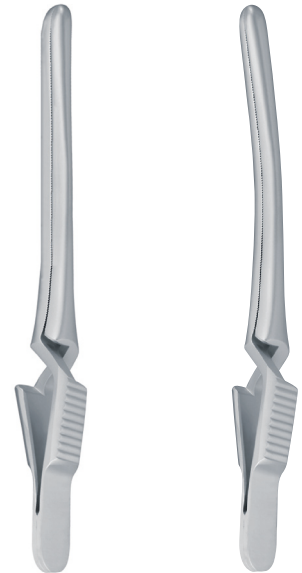

JOHNS-HOPKINS

38 mm – 1 ½ "	13-326-038	13-327-038
51 mm – 2 "	13-326-051	13-327-051
57 mm – 2 ¼ "	13-326-057	13-327-057
63 mm – 2 ½ "	13-326-063	13-327-063
70 mm – 2 ¾ "	13-326-070	13-327-070
75 mm – 3 "	13-326-075	13-327-075
90 mm – 3 ½ "	13-326-090	13-327-090

gerade
straight
droit
recta
retto

gebogen
curved
courbe
curva
curvo



DIETRICH

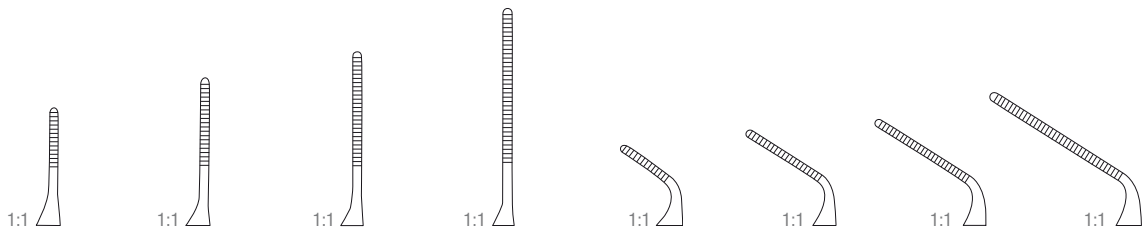

x =	50 mm – 2 "	50 mm – 2 "	50 mm – 2 "	60 mm – 2 ¼ "	50 mm – 2 "	50 mm – 2 "	50 mm – 2 "	60 mm – 2 ¼ "
y =	8 mm	12 mm	16 mm	20 mm	8 mm	12 mm	16 mm	20 mm
	13-450-008	13-450-012	13-450-016	13-450-020	13-451-008	13-451-012	13-451-016	13-451-020

x = Länge
x = Length
x = Longueur
x = longitud
x = Lunghezza

y = geriefte Maullänge
y = serrated jaw part
y = partie striée du mors
y = boca aserrada
y = morso zigrinato

Arterienklemmen Haemostatic forceps

Arterienklemmen
Haemostatic forceps
Pinces hémostatiques
Pinzas hemostáticas
Pinze emostatiche

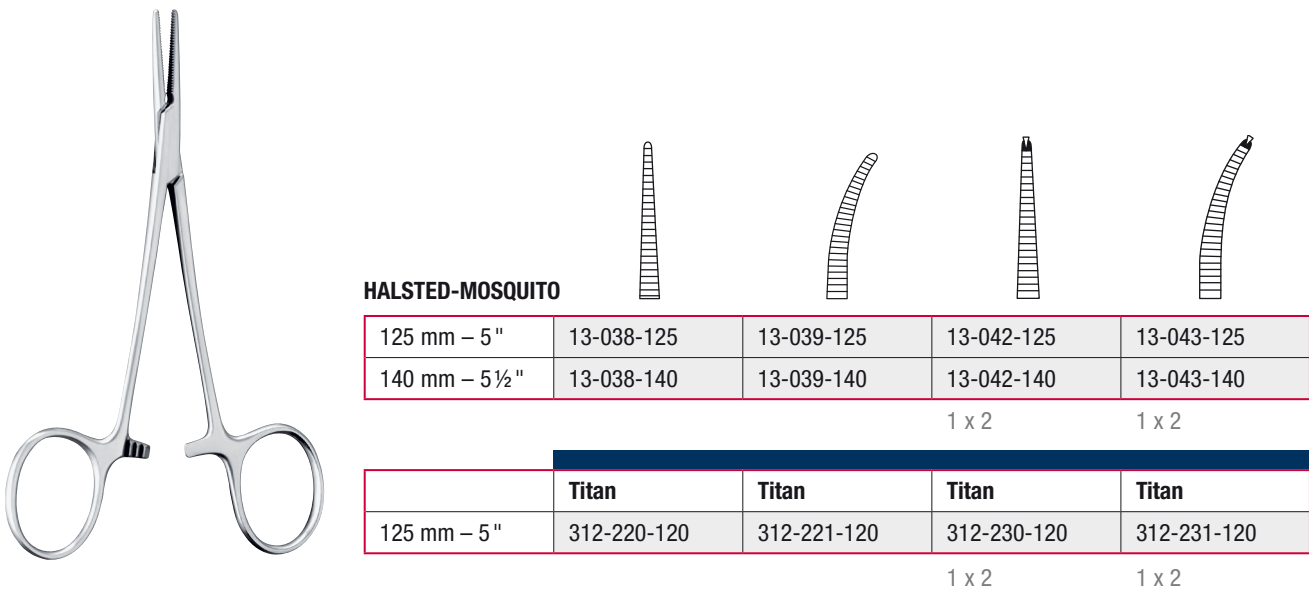
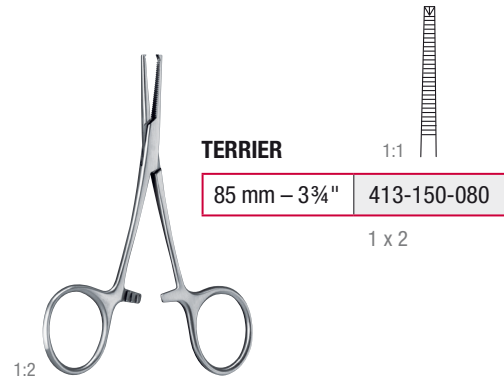
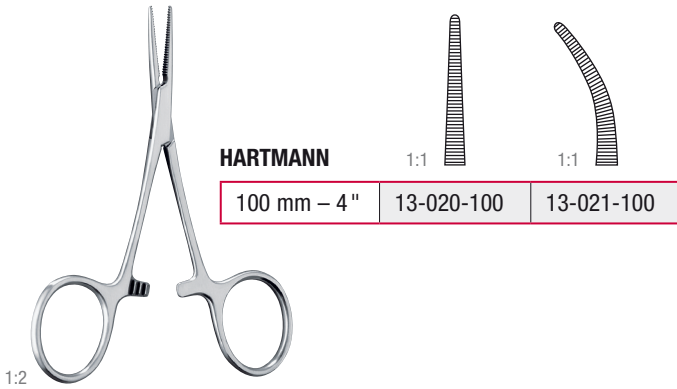

Arterienklemmen

Haemostatic forceps



Arterienklemmen
Haemostatic forceps
Pinces hémostatiques
Pinzas hemostáticas
Pinze emostatiche



MICRO-MOSQUITO

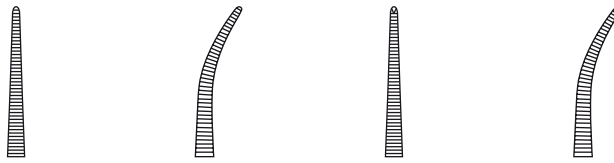

100 mm – 4"	13-028-100	13-029-100	13-030-100	13-031-100
120 mm – 4¾"	13-028-120	13-029-120	13-030-120	13-031-120

1 x 2

1 x 2



DANDY



130 mm – 4"	13-117-130	
140 mm – 5½"	13-117-140	413-353-140

1 x 2

seitlich gebogen
 curved to the side
 courbe sur le plat
 curva al lado
 curvata lateralmente

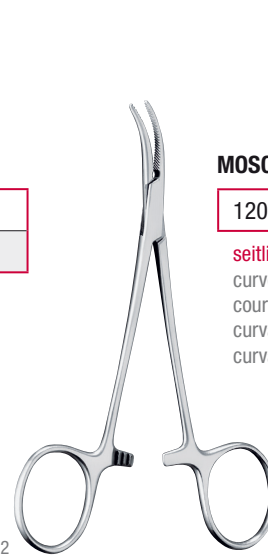

MOSQUITO-DANDY



1:1

120 mm – 4¾"	413-347-120
--------------	-------------

seitlich gebogen
 curved to the side
 courbe sur le plat
 curva al lado
 curvata lateralmente

1:2

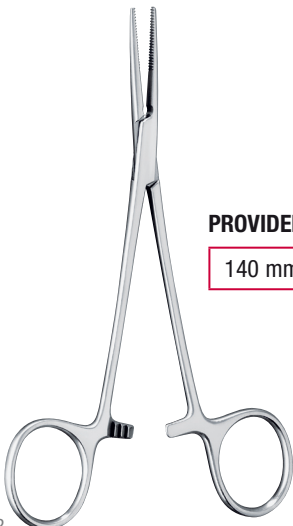

PROVIDENCE-HOSPITAL

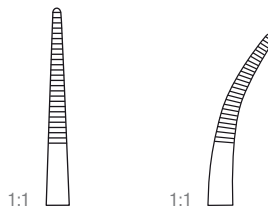

1:1

1:1

140 mm – 5½"	13-072-140	13-073-140
--------------	------------	------------

1:2

Arterienklemmen

Haemostatic forceps

Arterienklemmen
Haemostatic forceps
Pinces hémostatiques
Pinzas hemostáticas
Pinze emostatiche



CHRISTOPHE

130 mm – 4"	13-055-130
150 mm – 6"	13-055-150

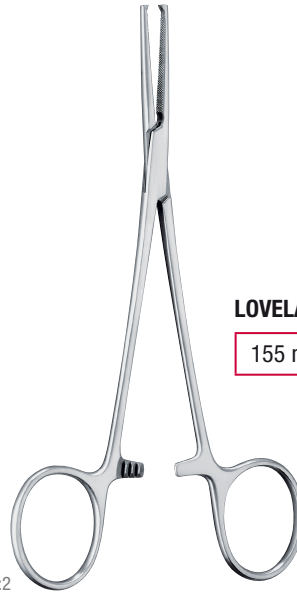

LOVELACE

155 mm – 6"	13-140-155	413-344-150
-------------	------------	-------------

1 x 2

1:2



LERICHE

150 mm – 6"	312-376-150	312-377-150
-------------	-------------	-------------

1:2

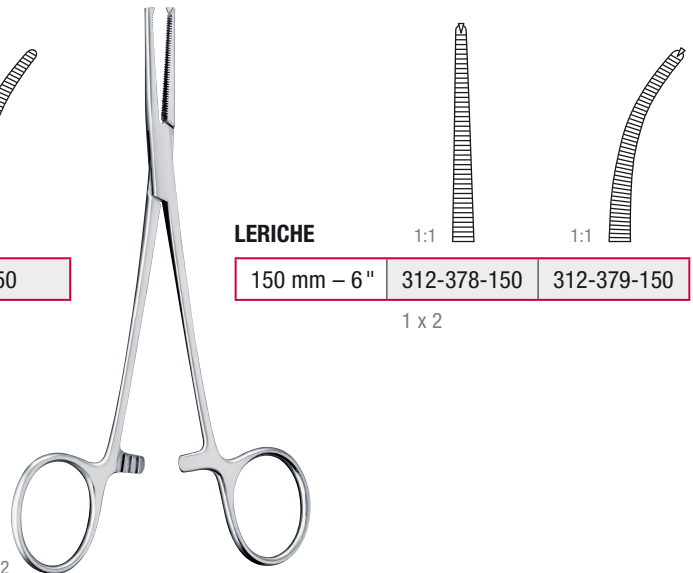

LERICHE

150 mm – 6"	312-378-150	312-379-150
-------------	-------------	-------------

1 x 2

1:2

Arterienklemmen

Haemostatic forceps



Arterienklemmen
Haemostatic forceps
Pinces hémostatiques
Pinzas hemostáticas
Pinze emostatiche

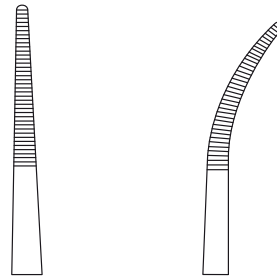

KELLY

140 mm – 5½"	13-078-140	13-079-140
--------------	------------	------------

KELLY-RANKIN

160 mm – 6¼"	13-082-160	13-083-160
--------------	------------	------------

KELLY

	Titan	Titan
140 mm – 5½"	312-240-140	312-241-140

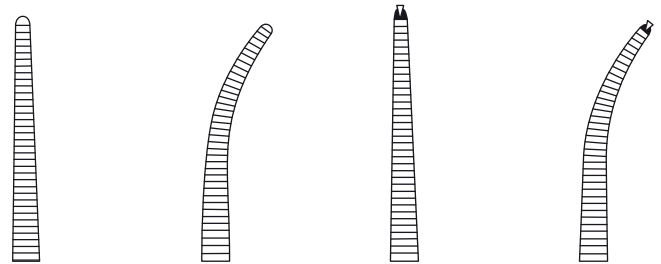

CRILE

140 mm – 5½"	13-090-140	13-091-140	13-092-140	13-093-140
			1 x 2	1 x 2

CRILE-RANKIN

160 mm – 6¼"	13-100-160	13-101-160	312-260-160	312-261-160
			1 x 2	1 x 2

CRILE

	Titan	Titan
140 mm – 5½"	312-250-140	312-251-140

Arterienklemmen

Haemostatic forceps

Arterienklemmen
Haemostatic forceps

Pinces hémostatiques
Pinzas hemostáticas
Pinze emostatiche



COLLER-CRILE

140 mm – 5 ½"	312-262-140	312-263-140
160 mm – 6 ¼"	312-262-160	312-263-160

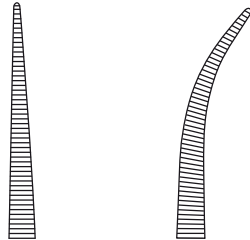

PÉAN

130 mm – 5"	413-370-130	413-371-130
140 mm – 5 ½"	312-308-140	312-309-140
160 mm – 6 ¼"	413-370-160	413-371-160

graziles Modell
delicate pattern
modèle délicat
modelo delicado
modello delicato

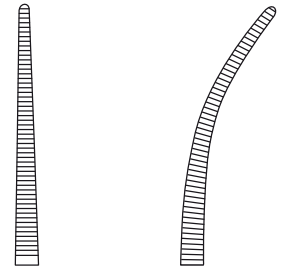

DUNHILL

125 mm – 5"	312-272-130	12-273-130
-------------	-------------	------------

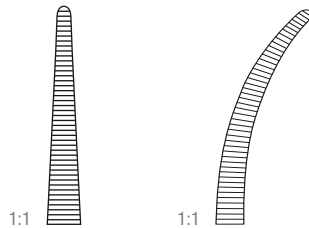

gebogen
curved
courbe
curva
curvo

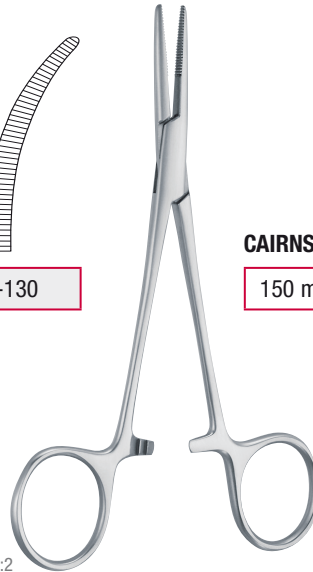

CAIRNS

150 mm – 6"	312-270-140	312-271-140
-------------	-------------	-------------

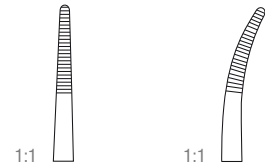

1:2

1:2



KOCHER

130 mm – 5"	413-380-130	413-381-130
140 mm – 5 ½"	312-318-140	312-319-140
160 mm – 6 ¼"	312-318-160	413-381-160

1 x 2

1 x 2

graziles Modell
delicate pattern
modèle délicat
modelo delicado
modello delicato

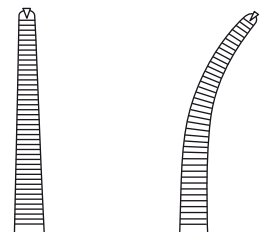

Arterienklemmen

Haemostatic forceps



Arterienklemmen
Haemostatic forceps
Pinces hémostatiques
Pinzas hemostáticas
Pinze emostatiche

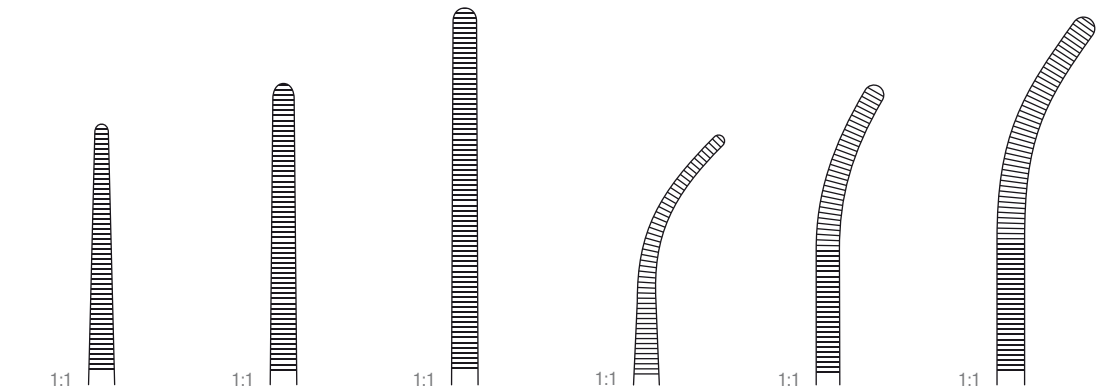

PÉAN-FINO

140 mm – 5 ½ "	165 mm – 6 ½ "	185 mm – 7 ¼ "	140 mm – 5 ½ "	160 mm – 6 ¼ "	180 mm – 7 "
413-376-140	413-376-160	413-376-180	413-377-140	413-377-160	413-377-180

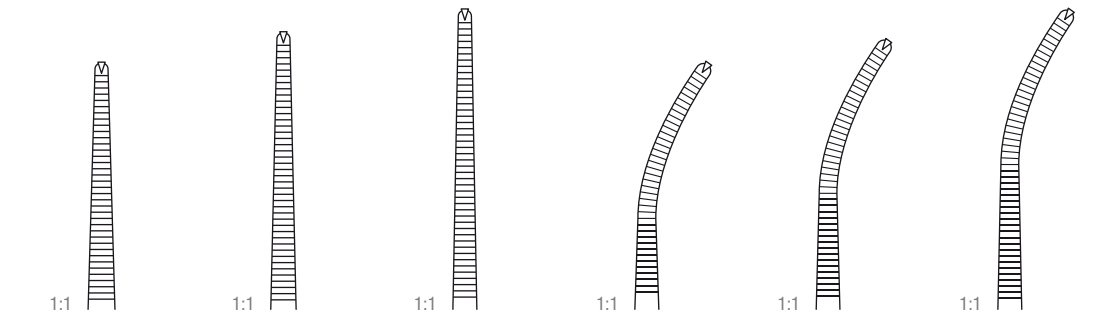

KOCHER-FINO

145 mm – 5 ¾ "	165 mm – 6 ½ "	185 mm – 7 ¼ "	145 mm – 5 ¾ "	160 mm – 6 ¼ "	180 mm – 7 "
413-378-140	413-378-160	413-378-180	413-379-140	413-379-160	413-379-180

1 x 2 1 x 2 1 x 2 1 x 2 1 x 2 1 x 2

Arterienklemmen

Haemostatic forceps

Arterienklemmen
Haemostatic forceps

Pinces hémostatiques
Pinzas hemostáticas
Pinze emostatiche

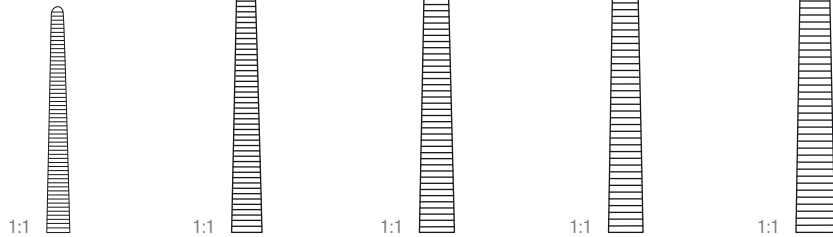
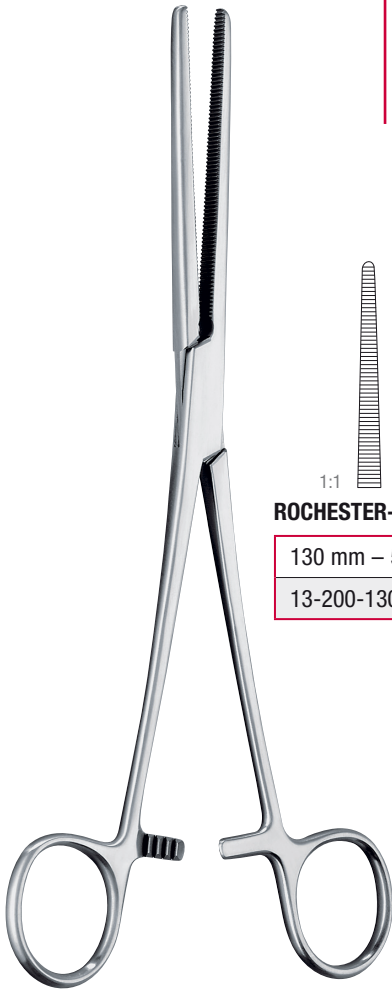

ROCHESTER-PÉAN

130 mm – 5"	140 mm – 5 ½"	160 mm – 6 ¼"	180 mm – 7"	200 mm – 8"
13-200-130	13-200-140	13-200-160	13-200-180	13-200-200

Atrauma	Atrauma	Atrauma	Atrauma
140 mm – 5 ½"	160 mm – 6 ¼"	180 mm – 7"	200 mm – 8"
313-078-140	313-078-160	313-078-180	313-078-200

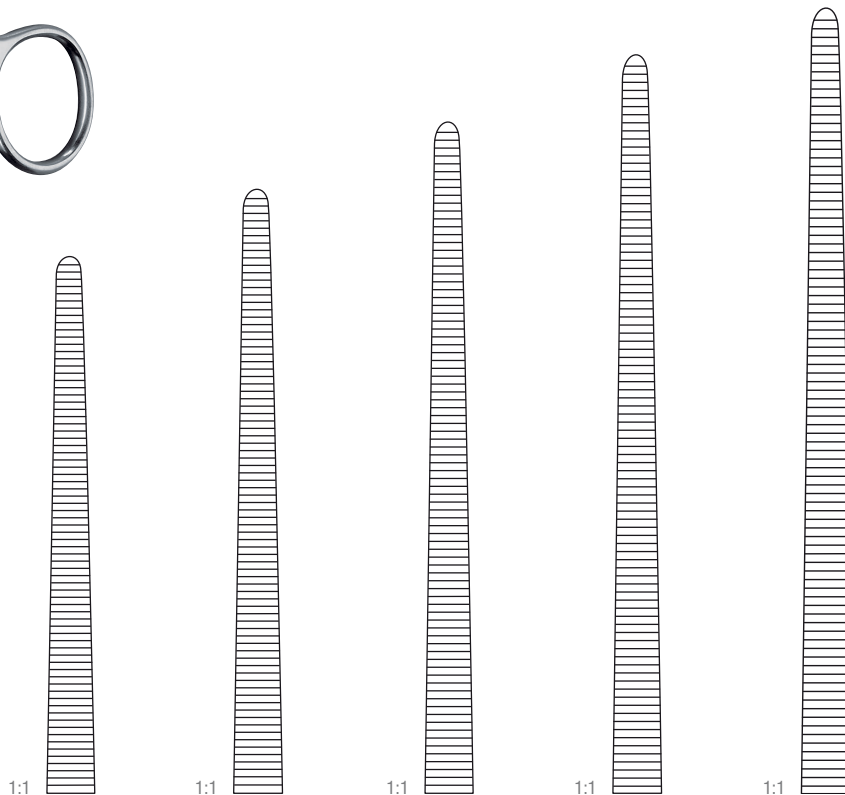

220 mm – 8 ¾"	240 mm – 9 ½"	260 mm – 10 ¼"	300 mm – 12"	350 mm – 14"
13-200-220	13-200-240	13-200-260	13-200-300	13-200-350

Atrauma	Atrauma
260 mm – 10 ¼"	300 mm – 12"
313-078-265	313-078-280

Arterienklemmen

Haemostatic forceps



Arterienklemmen
Haemostatic forceps
Pinces hémostatiques
Pinzas hemostáticas
Pinze emostatiche

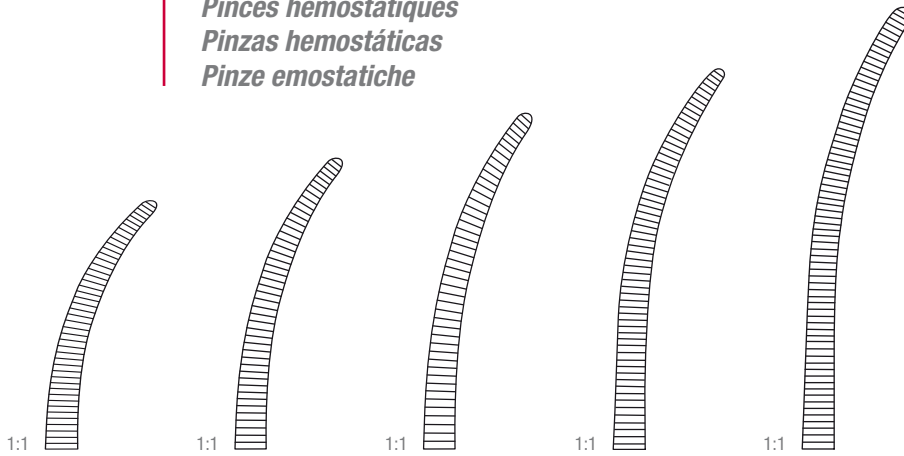

ROCHESTER-PÉAN

130 mm – 5"	140 mm – 5½"	160 mm – 6¼"	180 mm – 7"	200 mm – 8"
13-201-130	13-201-140	13-201-160	13-201-180	13-201-200

Atrauma	Atrauma	Atrauma	Atrauma
140 mm – 5½"	160 mm – 6¼"	180 mm – 7"	200 mm – 8"
313-079-140	313-079-160	313-079-180	313-079-200

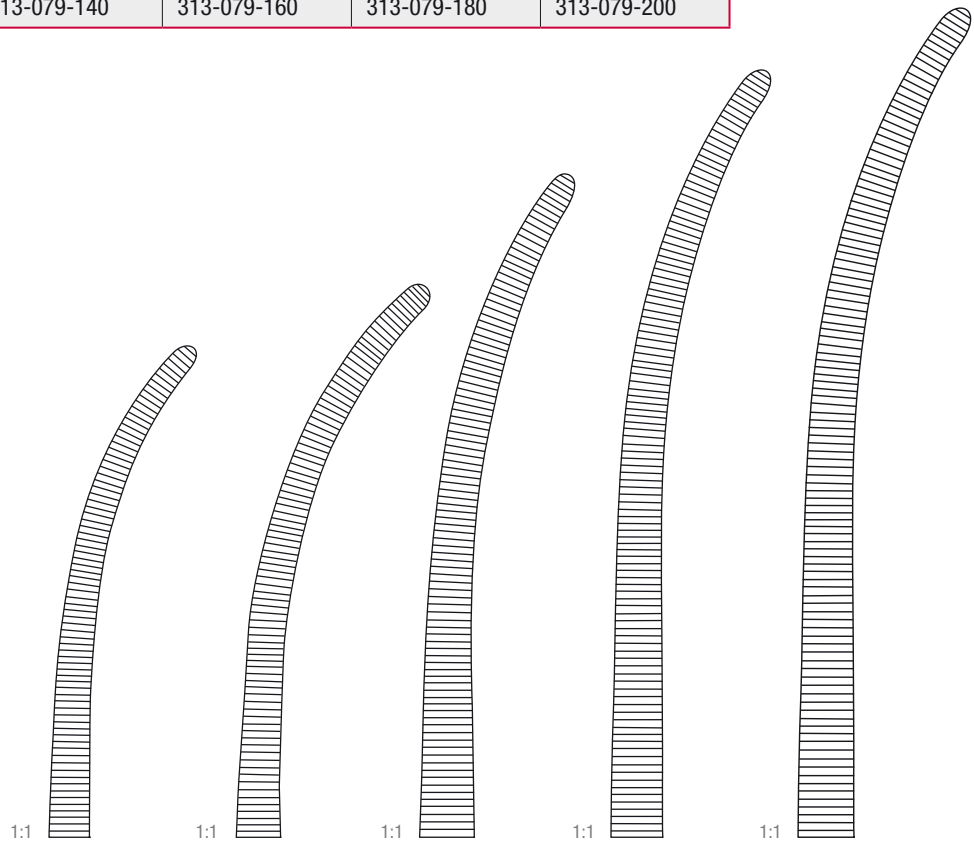

220 mm – 8¾"	240 mm – 9½"	260 mm – 10¼"	300 mm – 12"	350 mm – 14"
13-201-220	13-201-240	13-201-260	13-201-300	13-201-350

Atrauma	Atrauma
260 mm – 10¼"	300 mm – 12"
313-079-260	313-079-275

Arterienklemmen

Haemostatic forceps

Arterienklemmen
Haemostatic forceps

Pinces hémostatiques
Pinzas hemostáticas
Pinze emostatiche

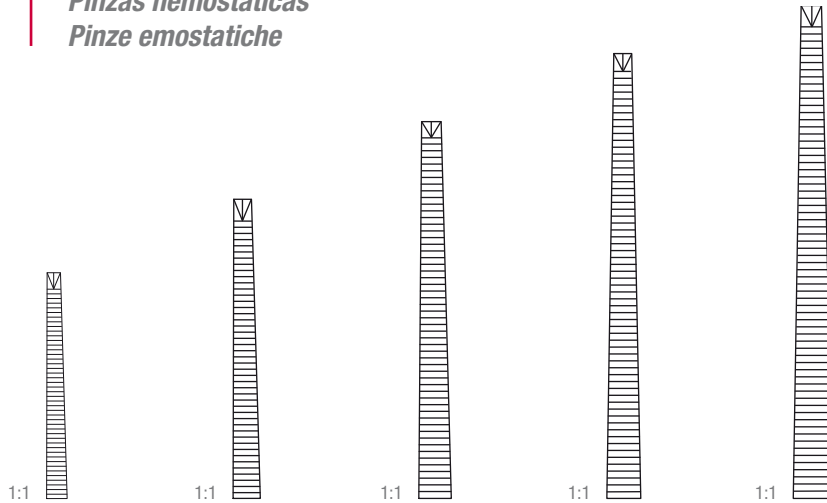

OCHSNER-KOCHER

130 mm – 5"	140 mm – 5½"	160 mm – 6¼"	180 mm – 7"	200 mm – 8"
13-214-130	13-214-140	13-214-160	13-214-180	13-214-200

1 x 2

1 x 2

1 x 2

1 x 2

1 x 2

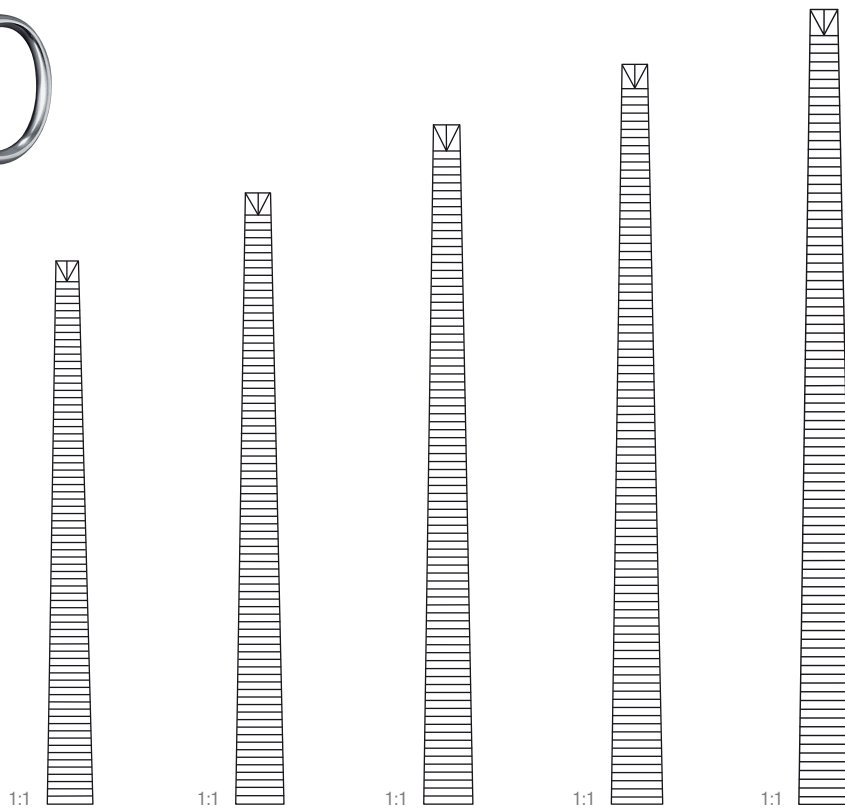

220 mm – 8¾"	240 mm – 9½"	260 mm – 10¼"	300 mm – 12"	300 mm – 14"
13-214-220	13-214-240	13-214-260	13-214-300	13-214-350

1 x 2

1 x 2

1 x 2

1 x 2

1 x 2

Arterienklemmen

Haemostatic forceps



Arterienklemmen
Haemostatic forceps
Pinces hémostatiques
Pinzas hemostáticas
Pinze emostatiche

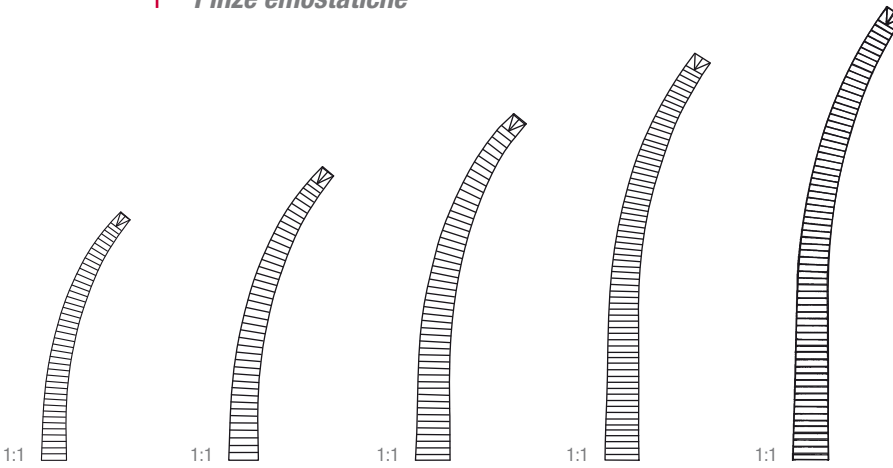

OCHSNER-KOCHER

130 mm – 5"	140 mm – 5½"	160 mm – 6¼"	180 mm – 7"	200 mm – 8"
13-215-130	13-215-140	13-215-160	13-215-180	13-215-200

1 x 2 1 x 2 1 x 2 1 x 2 1 x 2

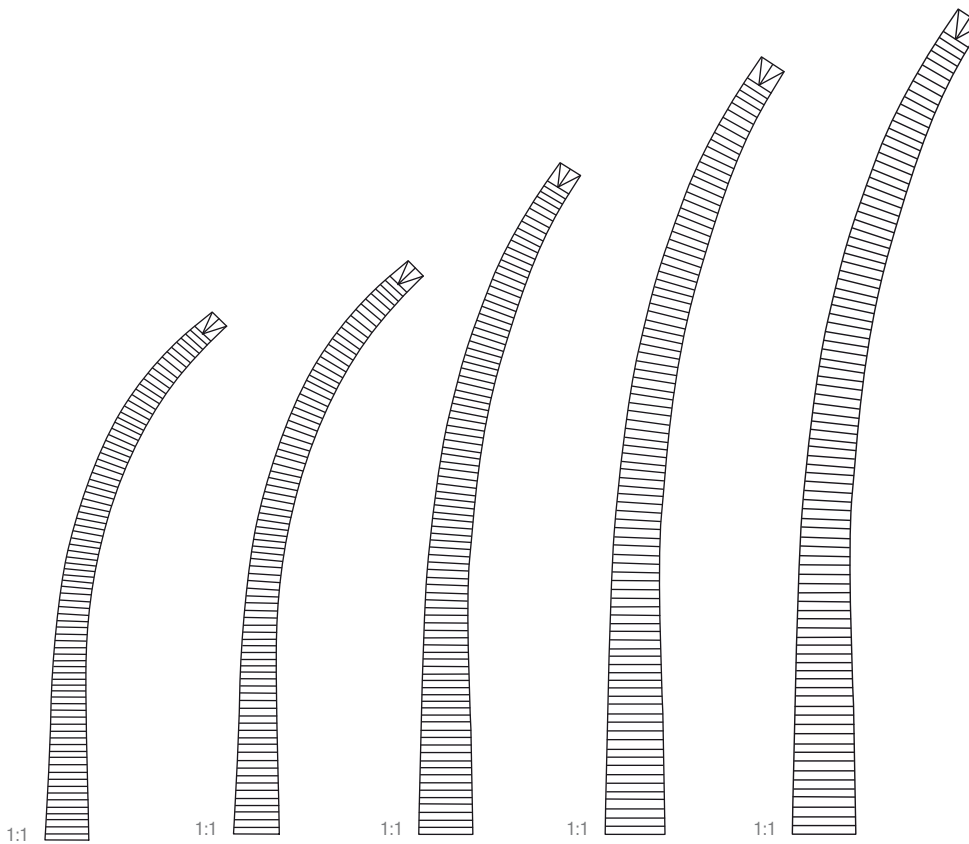

220 mm – 8¾"	240 mm – 9½"	260 mm – 10¼"	300 mm – 12"	350 mm – 14"
13-215-220	13-215-240	13-215-260	13-215-300	13-215-350

1 x 2 1 x 2 1 x 2 1 x 2 1 x 2

Arterienklemmen

Haemostatic forceps

Arterienklemmen
Haemostatic forceps
Pinces hémostatiques
Pinzas hemostáticas
Pinze emostatiche



BIRKETT

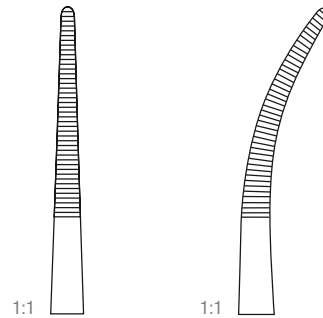

190 mm – 7½"	13-228-180	13-229-180
--------------	------------	------------



BAINBRIDGE

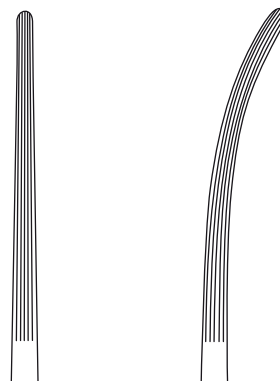

150 mm – 6"	13-148-150	13-149-150
185 mm – 7¼"	13-148-185	13-149-185

Arterienklemmen

Haemostatic forceps



Arterienklemmen
Haemostatic forceps
Pinces hémostatiques
Pinzas hemostáticas
Pinze emostatiche



PÉAN

140 mm – 5 ½ "	13-184-140
160 mm – 6 ¼ "	13-184-160



ROCHESTER-CARMALT

160 mm – 6 ¼ "	13-180-160	13-181-160
200 mm – 8 "	13-180-200	13-181-200



Arterienklemmen

Haemostatic forceps

Arterienklemmen
Haemostatic forceps

Pinces hémostatiques
Pinzas hemostáticas
Pinze emostatiche

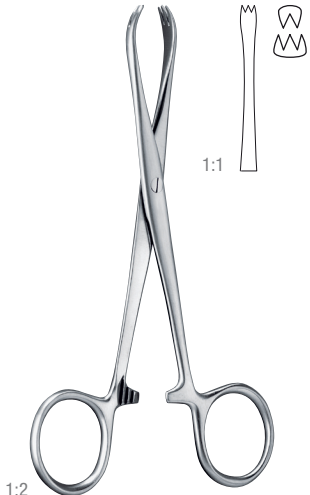

1:2

CHAPUT

130 mm – 5"	312-366-130
-------------	-------------

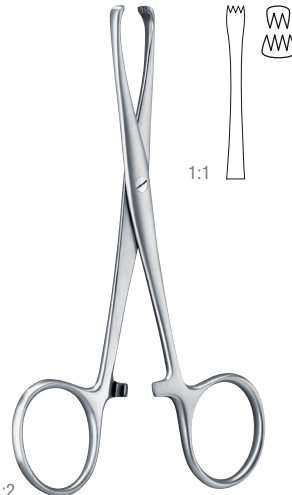

1:2

TUFFIER

130 mm – 5"	312-368-130
-------------	-------------



PENNINGTON

155 mm – 6"	13-124-155
200 mm – 8"	13-124-200

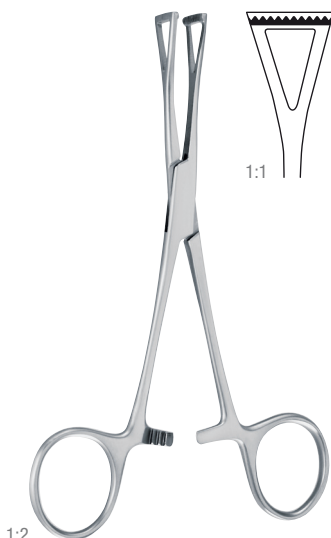

1:2

COLLIN

140 mm – 5½"	312-370-140
--------------	-------------



1:2

PRATT

150 mm – 6"	13-134-150
-------------	------------



1:2

MARTEL

140 mm – 5½"	312-360-140
--------------	-------------

Arterienklemmen

Haemostatic forceps



Arterienklemmen
Haemostatic forceps
Pinces hémostatiques
Pinzas hemostáticas
Pinze emostatiche



FERGUSSON

160 mm – 6 ¼ "	312-346-160	312-367-160
200 mm – 8 "	312-346-200	312-367-200

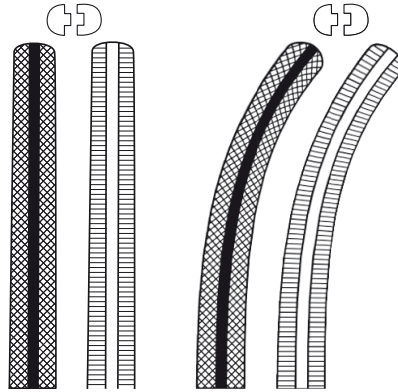

gebogen
 curved
 courbe
 curva
 curvo

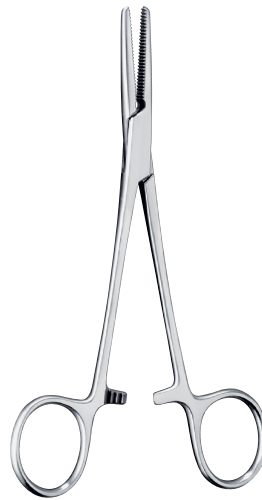

SPENCER-WELLS

130 mm – 5 "	13-190-130	13-191-130
140 mm – 5 ½ "	13-190-140	13-191-140
155 mm – 6 "	13-190-150	13-191-150
180 mm – 7 "	13-190-180	13-191-180
200 mm – 8 "	13-190-200	13-191-200

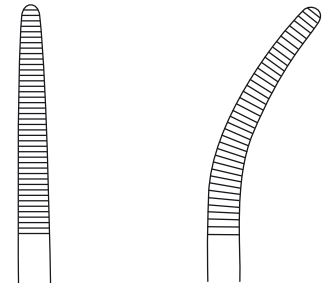

HALSTED-MOSQUITO

180 mm – 7 "	13-048-180	13-049-180	13-050-180	13-051-180
210 mm – 8 ¼ "	312-216-210	312-217-210	312-226-210	312-227-210

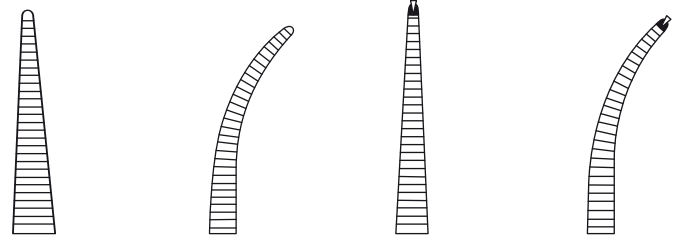

1 x 2

1 x 2

Arterienklemmen

Haemostatic forceps

Arterienklemmen
Haemostatic forceps

Pinces hémostatiques
Pinzas hemostáticas
Pinze emostatiche

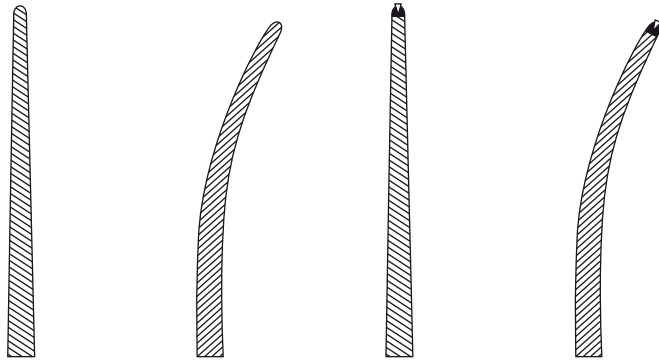

BENGOLEA

200 mm – 8"	13-240-200	13-241-200	13-242-200	13-243-200
260 mm – 10¼"	13-240-260	13-241-260	13-242-260	13-243-260

1 x 2

1 x 2



1:2

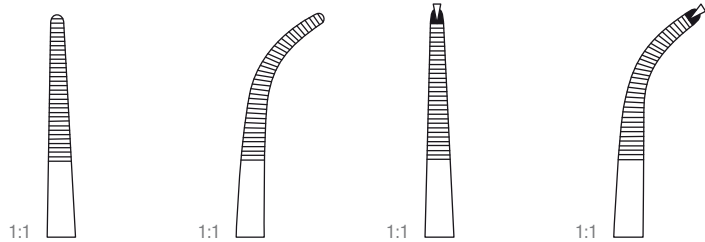

ADSON

185 mm – 7¼"	13-160-185	13-161-185	13-166-185	13-167-185
--------------	------------	------------	------------	------------

1 x 2

1 x 2

Arterienklemmen

Haemostatic forceps



Arterienklemmen
Haemostatic forceps
Pinces hémostatiques
Pinzas hemostáticas
Pinze emostatiche

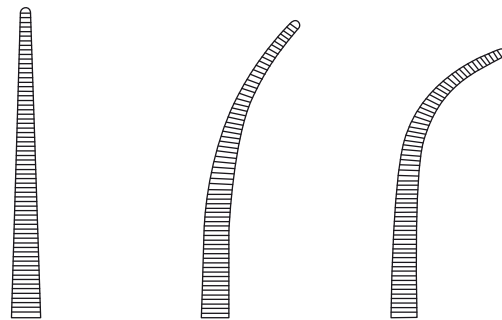

HEISS

200 mm – 8"	13-224-200	13-225-200	13-227-200
230 mm – 9"	13-224-230	13-225-230	13-227-230

Arterienklemmen

Haemostatic forceps

Arterienklemmen
Haemostatic forceps
Pinces hémostatiques
Pinzas hemostáticas
Pinze emostatiche



BABY-MIXTER

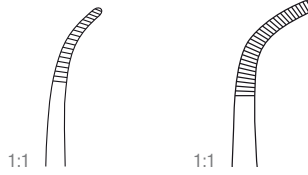

140 mm – 5 ½"	312-471-140	
180 mm – 7"		312-471-180



BABY-ADSON

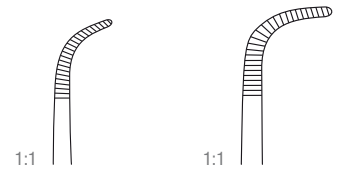

140 mm – 5 ½"	413-417-140	
180 mm – 7"		312-411-180



BABY-OVERHOLT

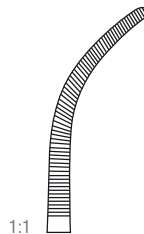

135 mm – 5 ¼"	413-335-140
---------------	-------------

1:2

Arterienklemmen

Haemostatic forceps



Arterienklemmen
Haemostatic forceps
Pinces hémostatiques
Pinzas hemostáticas
Pinze emostatiche

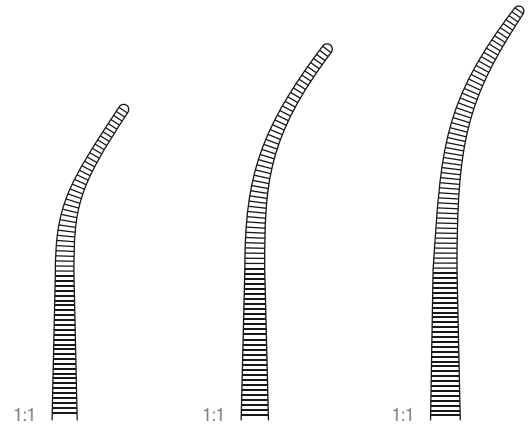
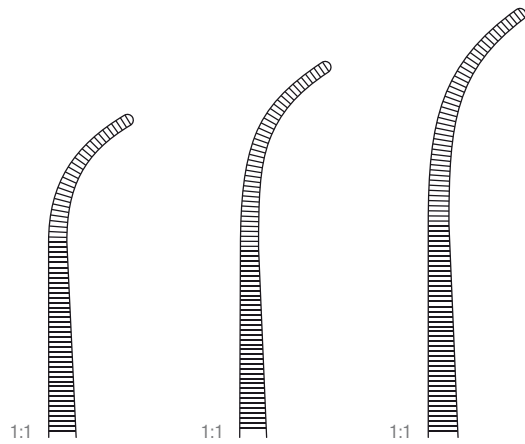

Fig. 1	Fig. 1	Fig. 1
195 mm – 7 ¾"	225 mm – 8 ¾"	245 mm – 9 ¾"
413-573-190	413-573-220	413-573-240



KELLY-FRASER

Fig. 2	Fig. 2	Fig. 2
190 mm – 7 ½"	220 mm – 8 ¾"	240 mm – 9 ½"
413-575-190	413-575-220	413-575-240

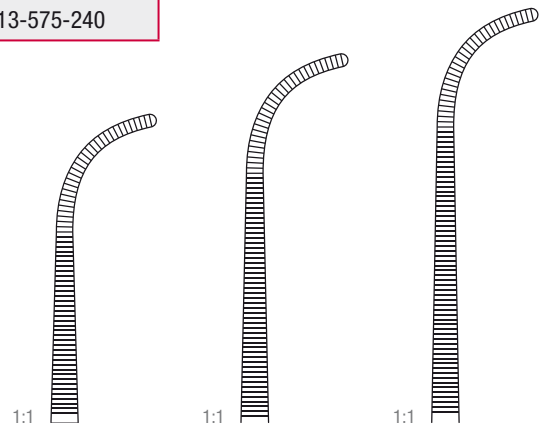

Fig. 3	Fig. 3	Fig. 3
185 mm – 7 ¼"	215 mm – 8 ½"	235 mm – 9 ¼"
413-577-190	413-577-220	413-577-240

Arterienklemmen

Haemostatic forceps

Arterienklemmen
Haemostatic forceps
Pinces hémostatiques
Pinzas hemostáticas
Pinze emostatiche



1:2

SCHNIDT

1:1



1:1

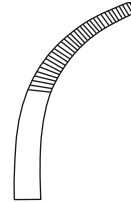

190 mm – 7 ½"	13-531-190	13-533-190
---------------	------------	------------



TOENNIS

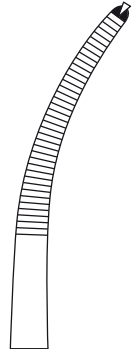
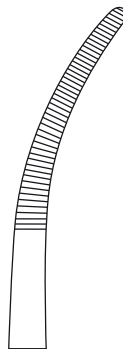

210 mm – 8 ¼"	312-438-210	312-439-210	312-440-210	312-441-210
260 mm – 10 ¼"	312-438-260	312-439-260	312-440-260	312-441-260

1 x 2

1 x 2

Arterienklemmen

Haemostatic forceps



Arterienklemmen
Haemostatic forceps
Pinces hémostatiques
Pinzas hemostáticas
Pinze emostatiche



1:2

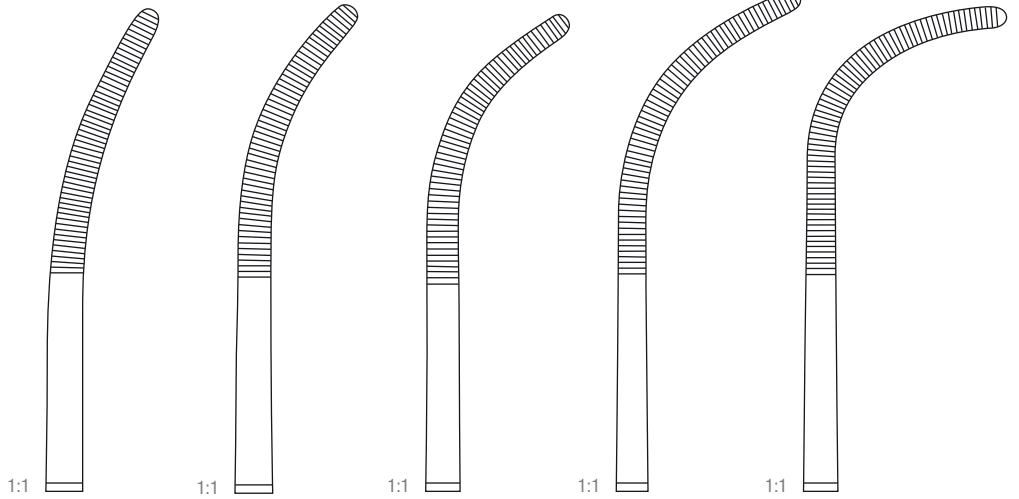

RUMEL

	Fig. 1	Fig. 2	Fig. 3	Fig. 4	Fig. 5
240 mm – 9½"	13-485-001	13-485-001	13-485-003	13-485-004	13-485-005



MEEKER

180 mm – 7"	312-455-180
275 mm – 10¾"	312-455-280

gebogen, 90°
 curved, 90°
 courbe, 90°
 curva, 90°
 curve, 90°

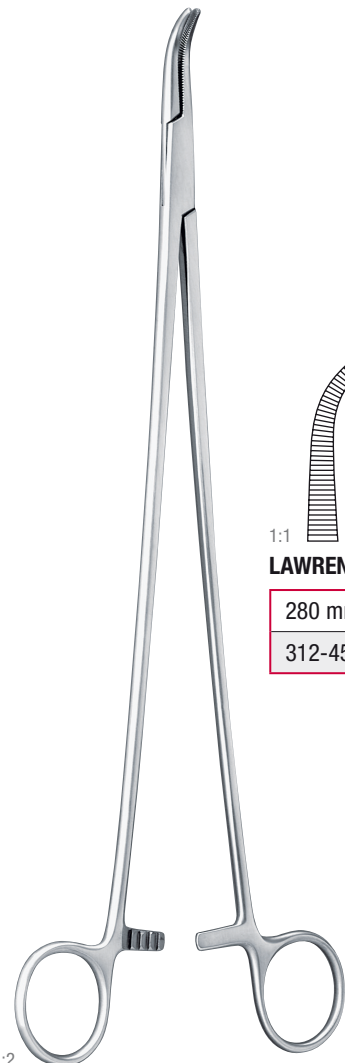

1:2

1:1

LAWRENCE

280 mm – 11"
312-453-280

Arterienklemmen

Haemostatic forceps

Präparier- und Ligaturklemmen

Dissecting and ligature forceps

Pinces à disséquer et à sutures
Pinzas para preparación y suturas
Pinze per preparazioni e suture



**OVERHOLT-
GEISSENDOERFER**

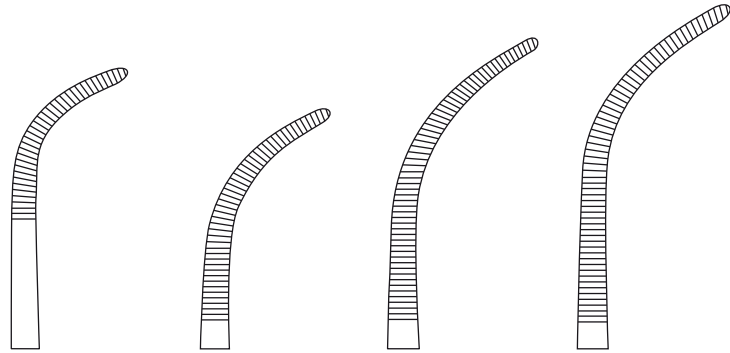

	Fig. 1	Fig. 2	Fig. 3	Fig. 4
210 mm – 8 ¼ "	13-469-001	13-469-002	13-469-003	13-469-004
270 mm – 10 ¾ "	312-423-010	312-423-020	312-423-030	312-423-040

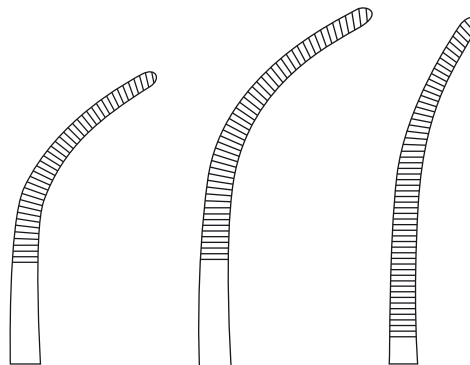

	Fig. 5	Fig. 6	Fig. 7
210 mm – 8 ¼ "	13-469-005	13-469-006	13-469-007
270 mm – 10 ¾ "	312-423-050	312-423-060	312-423-070

Arterienklemmen

Haemostatic forceps



Präparier- und Ligaturklemmen
Dissecting and ligature forceps
Pinces à disséquer et à sutures
Pinzas para preparación y suturas
Pinze per preparazioni e suture

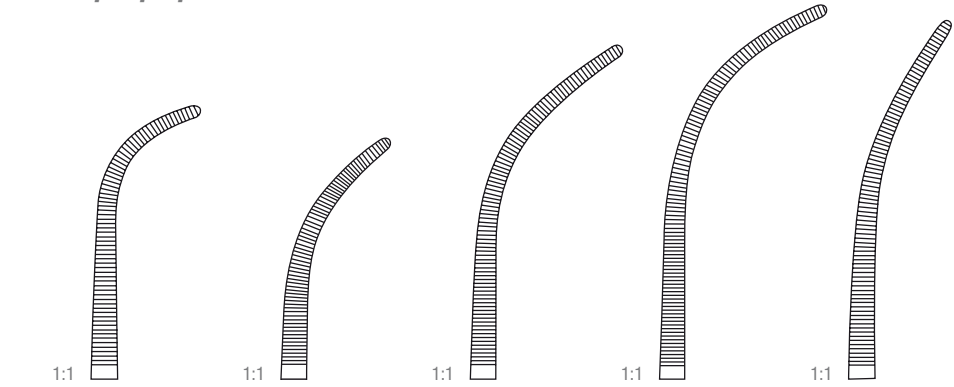

OVERHOLT-FINO

Fig. 0	Fig. 1	Fig. 2	Fig. 3	Fig. 6
215 mm – 8½"	210 mm – 8¼"	220 mm – 8¾"	230 mm – 9"	225 mm – 8¾"
13-471-000	13-471-001	13-471-002	13-471-003	13-471-006

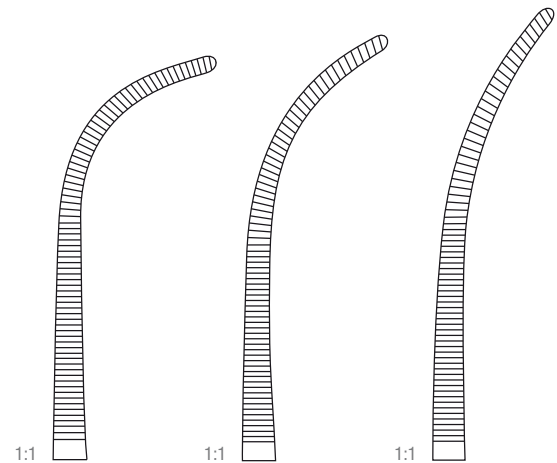

OVERHOLT

Fig. 0	Fig. 1	Fig. 6
295 mm – 8½"	295 mm – 8½"	300 mm – 8¾"
312-425-000	312-425-001	312-425-006

Arterienklemmen

Haemostatic forceps

Präparier- und Ligaturklemmen

Dissecting and ligature forceps

Pinces à disséquer et à sutures
Pinzas para preparación y suturas
Pinze per preparazioni e suture

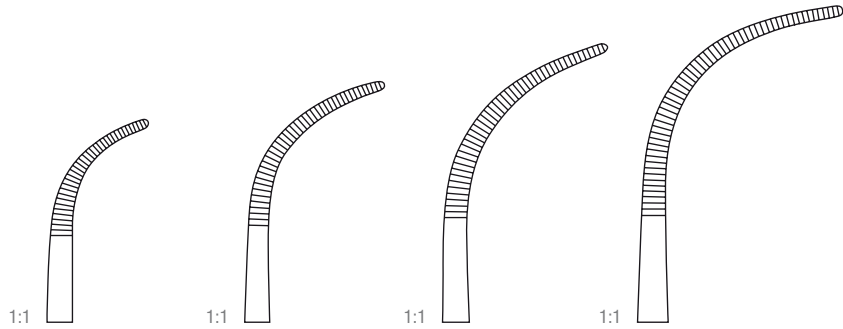

OVERHOLT-MODIFIZIERT

185 mm – 7 ¼"	205 mm – 8"	210 mm – 8 ¼"	215 mm – 8 ½"
413-413-010	413-413-020	413-413-030	413-413-040

S-förmig gebogen
S-curved
courbe en S
curva en S
curve a forma di S



OVERHOLT-MIXTER

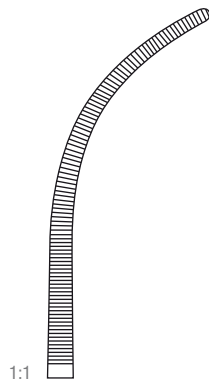

210 mm – 8 ¼"	413-423-210
---------------	-------------

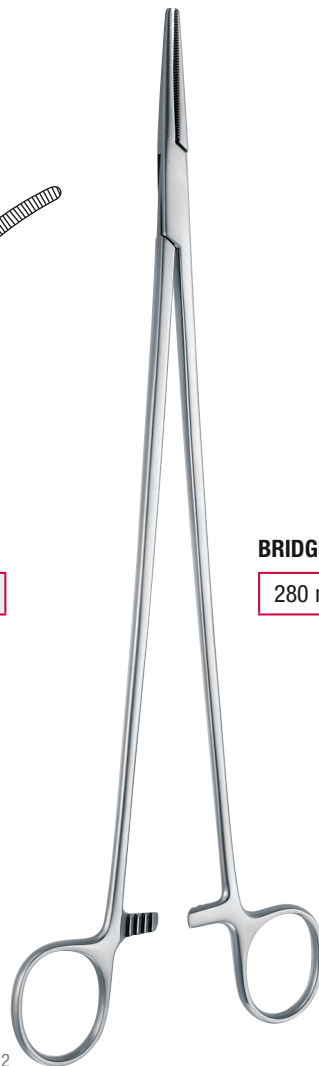

BRIDGE

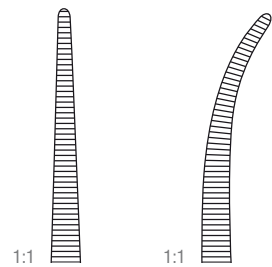

280 mm – 11"	312-452-275	312-453-275
--------------	-------------	-------------

1:2

1:2

Arterienklemmen

Haemostatic forceps



Präparier- und Ligaturklemmen

Dissecting and ligature forceps

Pinces à disséquer et à sutures
Pinzas para preparación y suturas
Pinze per preparazioni e suture

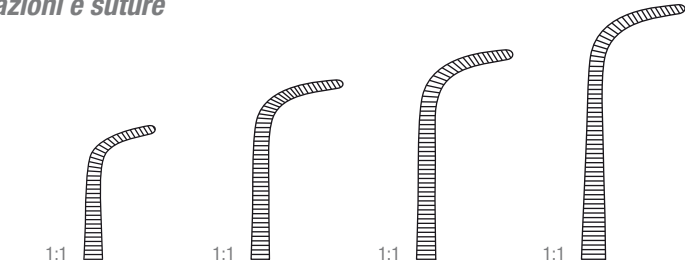

GEMINI

130 mm – 5"	160 mm – 6¼"	180 mm – 7"	200 mm – 8"
312-427-130	312-427-160	312-427-180	312-427-200

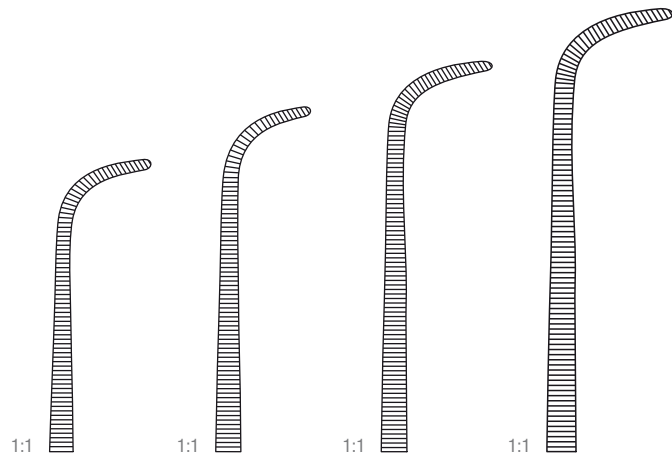

230 mm – 9"	250 mm – 9¾"	280 mm – 11"	350 mm – 14"
312-427-230	312-427-250	312-427-280	312-427-350

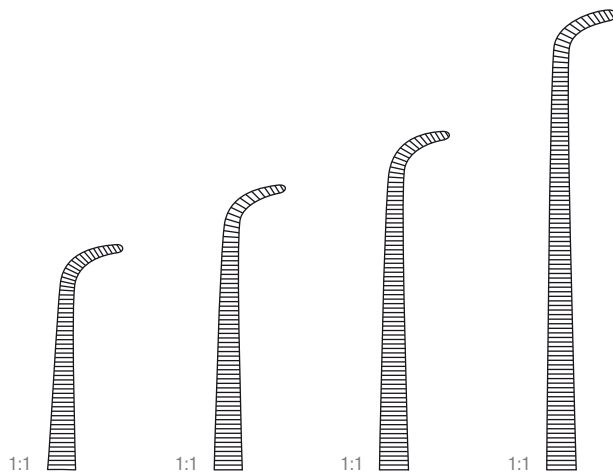

GEMINI-MINI

180 mm – 7"	220 mm – 8¾"	250 mm – 9¾"	280 mm – 11"
312-429-180	312-429-220	312-429-250	312-429-280

Arterienklemmen

Haemostatic forceps

Präparier- und Ligaturklemmen
Dissecting and ligature forceps

Pinces à disséquer et à sutures
Pinzas para preparación y suturas
Pinze per preparazioni e suture



1:2

ZENKER

1:1

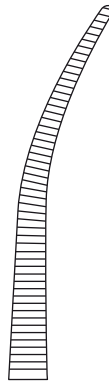

1:1

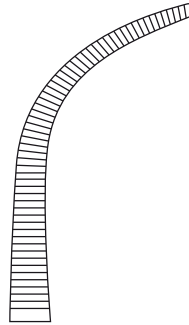

295 mm – 11 ½"

312-451-010

312-451-020



1:2

ROBERTS

1:1



1:1

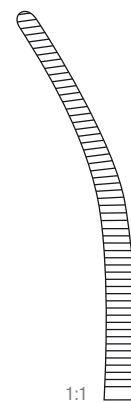

220 mm – 8 ¾"

13-268-220

13-269-220

Arterienklemmen

Haemostatic forceps



Präparier- und Ligaturklemmen

Dissecting and ligature forceps

Pinces à disséquer et à sutures
Pinzas para preparación y suturas
Pinze per preparazioni e suture



MIXTER

140 mm – 6"	312-467-140
155 mm – 6"	312-467-160
190 mm – 7 ½"	312-467-180
230 mm – 9"	312-467-230

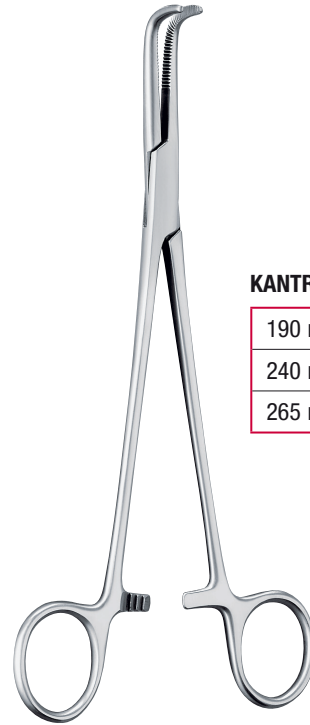
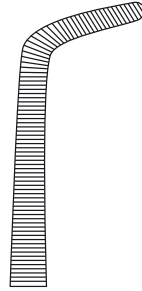

KANTROWITZ

190 mm – 7 ½"	312-457-190
240 mm – 9 ½"	312-457-240
265 mm – 10 ½"	312-457-265

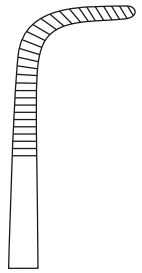

MIXTER

230 mm – 9"	13-557-230
-------------	------------

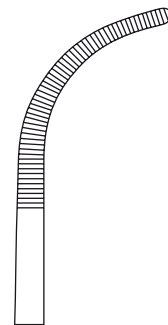

Arterienklemmen

Haemostatic forceps

Präparier- und Ligaturklemmen
Dissecting and ligature forceps

Pinces à disséquer et à sutures
Pinzas para preparación y suturas
Pinze per preparazioni e suture



MIXTER

230 mm – 9"

413-481-230

1:1

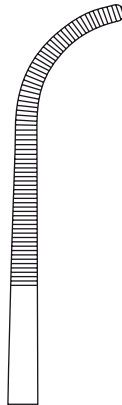

1:2

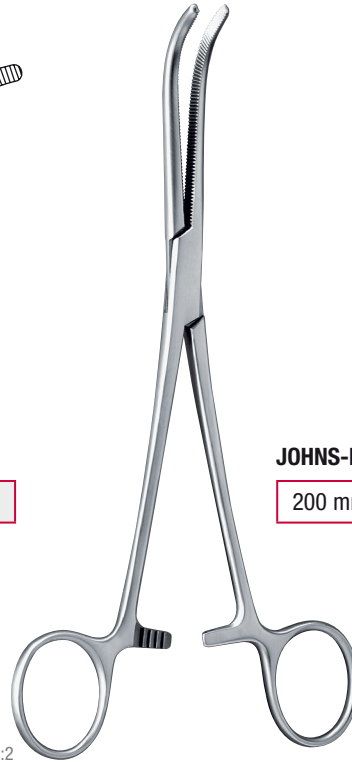

JOHNS-HOPKINS

200 mm – 8"

312-493-200

1:1

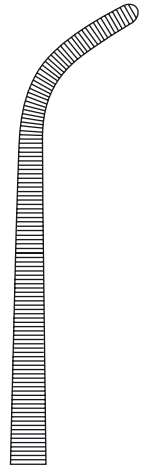

MIXTER-O'SHAUGNESSY

155 mm – 6"

312-473-150

190 mm – 7½"

312-473-190

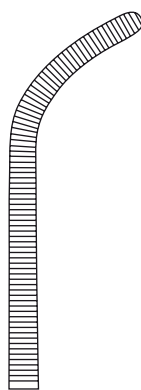

Arterienklemmen

Haemostatic forceps



Präparier- und Ligaturklemmen
Dissecting and ligature forceps
Pinces à disséquer et à sutures
Pinzas para preparación y suturas
Pinze per preparazioni e suture



WICKSTRÖM

210 mm – 8 ¼"	413-483-210
240 mm – 9 ½"	413-483-240

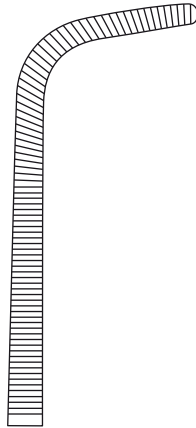

CRAFOORD

180 mm – 7"	413-435-180
240 mm – 9 ½"	13-261-240

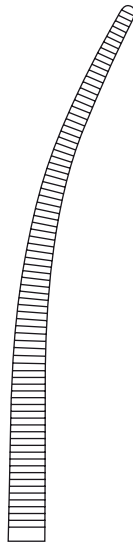

SAROT

240 mm – 9 ½"	13-274-240	13-275-240
---------------	------------	------------

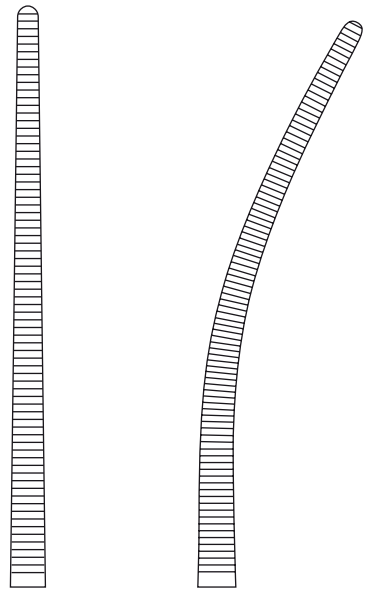

Arterienklemmen

Haemostatic forceps

Präparier- und Ligaturklemmen

Dissecting and ligature forceps

Pinces à disséquer et à sutures
Pinzas para preparación y suturas
Pinze per preparazioni e suture

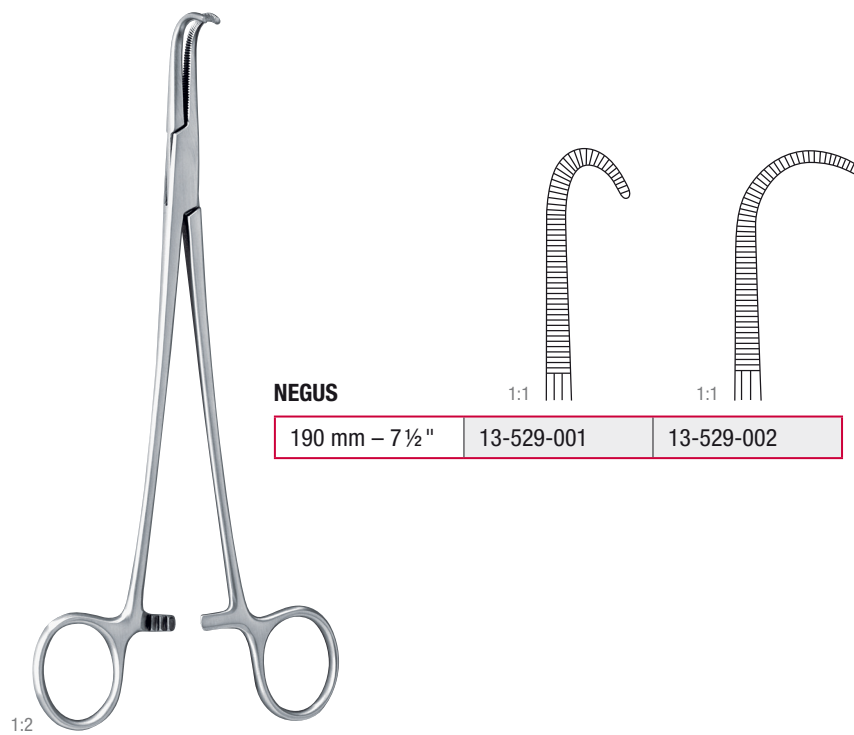
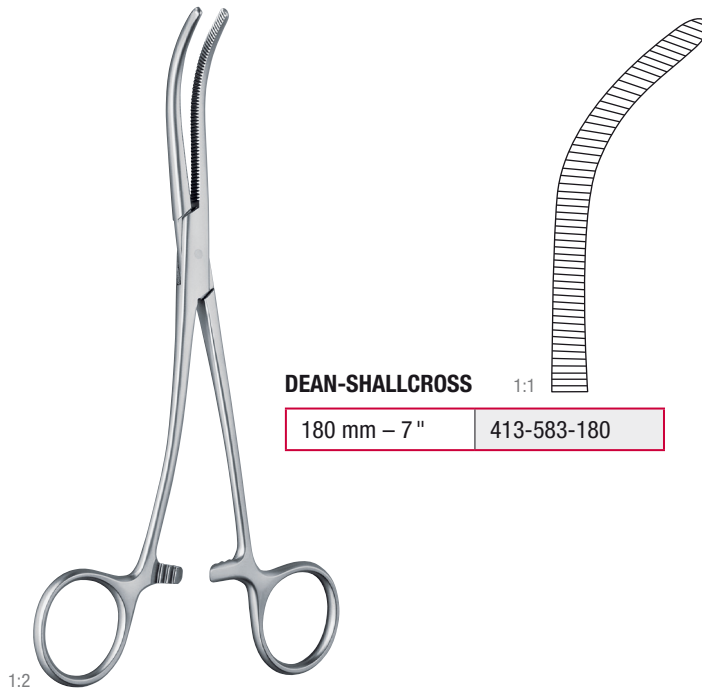

Arterienklemmen

Haemostatic forceps



Gallenkanal- und Nierenstielklemmen

Kidney pedicle and gall duct forceps

Pinces pour pédicules renaux et voies biliaires
Pinzas para pedículos renales y conductos biliares
Pinze per peduncoli renali e vie biliari



1:2

LOWER

180 mm – 7"

312-491-180

1:1

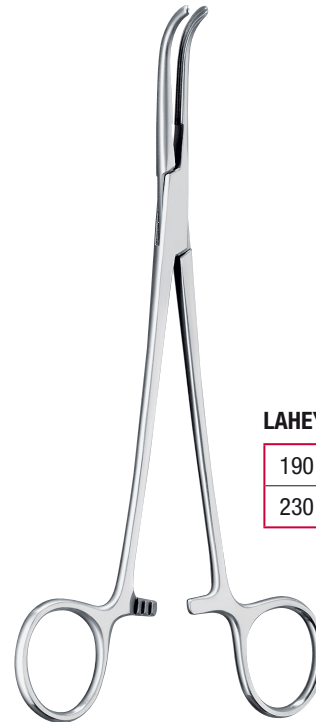
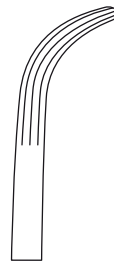

LAHEY

190 mm – 7½"

13-623-190

230 mm – 9"

13-625-235

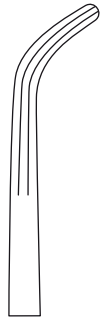

1:2

MCQUIGG-MIXTER

220 mm – 8¾"

413-493-220

1:1

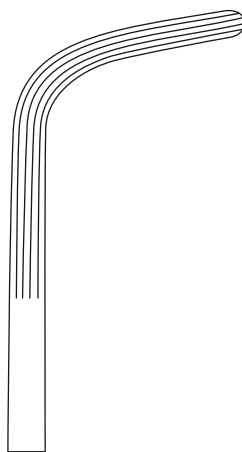

Arterienklemmen

Haemostatic forceps

Gallenkanal- und Nierenstielklemmen

Kidney pedicle and gall duct forceps

Pinces pour pédicules renaux et voies biliaires
Pinzas para pedículos renales y conductos biliares
Pinze per peduncoli renali e vie biliari

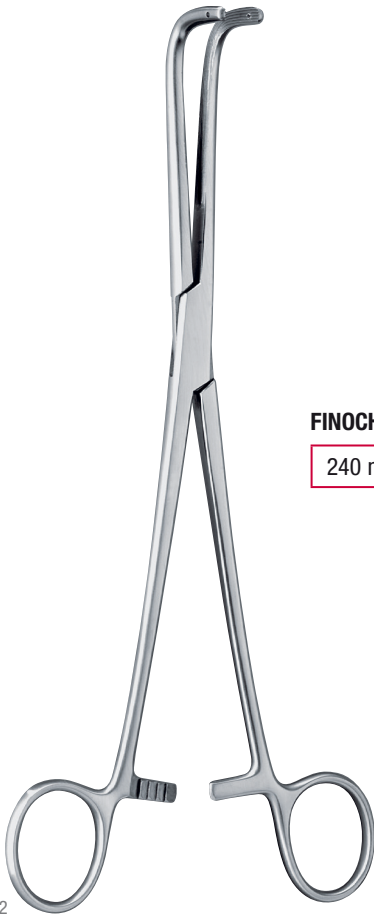

FINOCHIETTO

240 mm – 9 ½ "

356-303-240

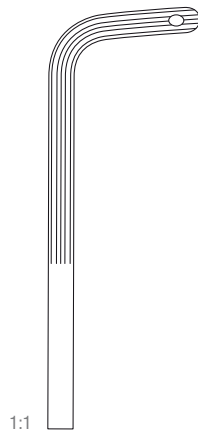

1:1



MIXTER

220 mm – 8 ¾ "

250 mm – 9 ¾ "

280 mm – 11 "

13-561-230

13-563-250

13-565-280

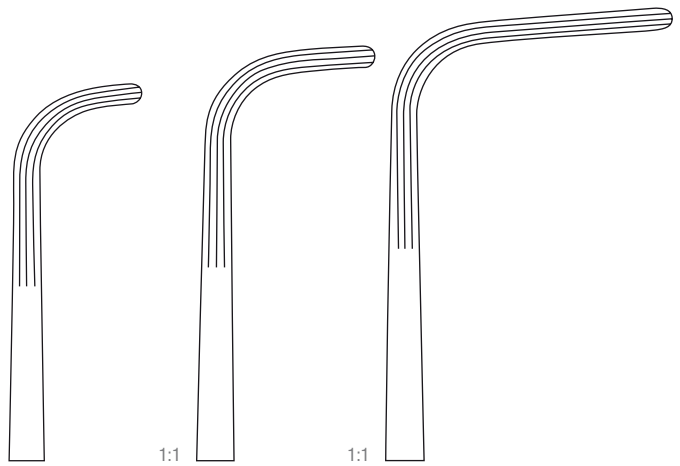

1:1

1:1

1:1

Arterienklemmen

Haemostatic forceps



Gallenkanal- und Nierenstiellklemmen

Kidney pedicle and gall duct forceps

Pinces pour pédicules renaux et voies biliaires
Pinzas para pedículos renales y conductos biliares
Pinze per peduncoli renali e vie biliari

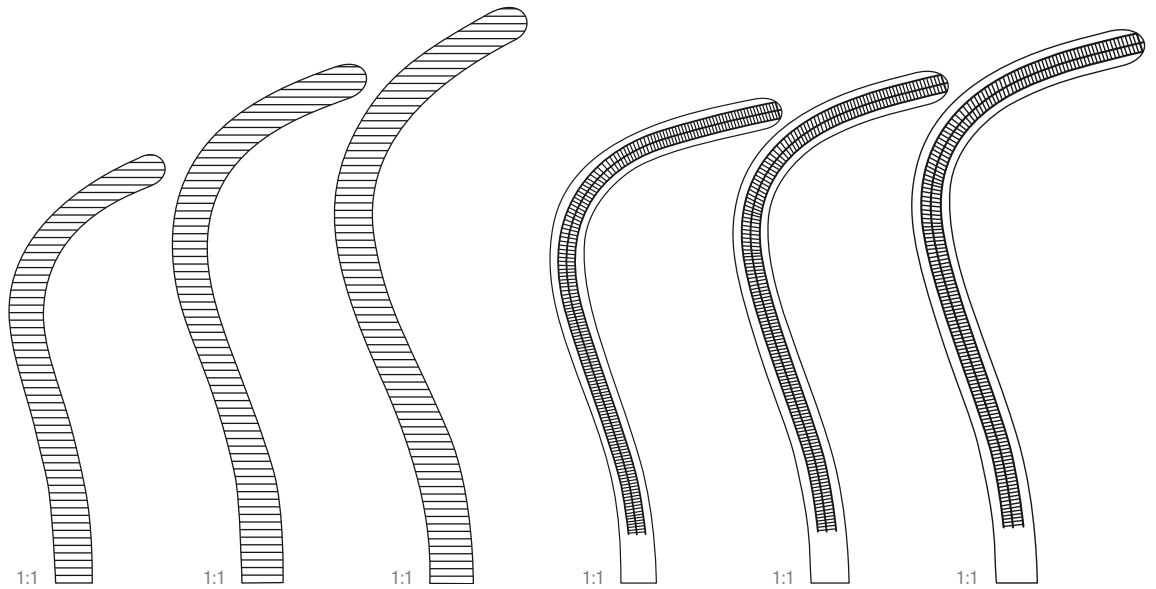

GUYON

			Atrauma	Atrauma	Atrauma
200 mm – 8"	220 mm – 8¾"	240 mm – 9½"	225 mm – 9"	230 mm – 9"	240 mm – 9½"
312-515-200	312-515-220	312-515-240	413-525-225	413-525-230	413-525-240

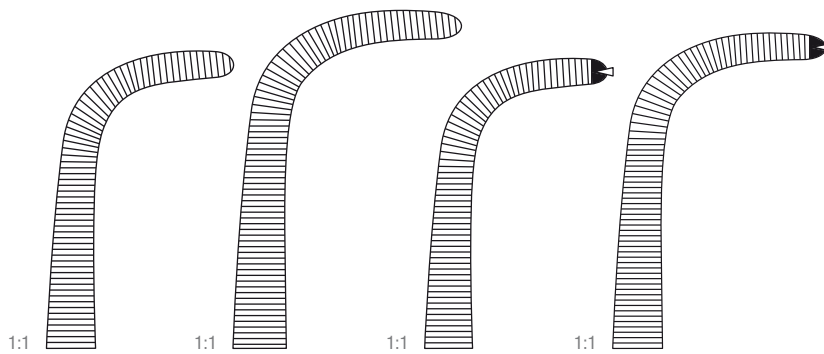

GRAY

Fig. 1	Fig. 2	Fig. 1	Fig. 2
220 mm – 8¾"	230 mm – 9"	220 mm – 8¾"	230 mm – 9"
312-503-220	312-503-230	312-505-220	312-505-230

1 x 2

1 x 2

Arterienklemmen

Haemostatic forceps

Nierenstiellklemmen

Kidney pedicle forceps

Pinces pour pédicules renaux
Pinzas para pedículos renales
Pinze per peduncoli renali



1:2

HERRICK 1:1

230 mm – 9"	312-519-230
-------------	-------------

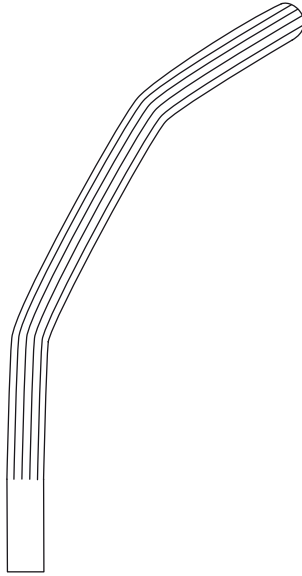

1:2

GUYON 1:1

230 mm – 9"	312-513-230
-------------	-------------

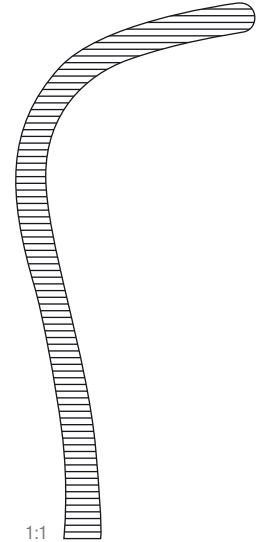

1:2

MAYO-GUYON 1:1

230 mm – 9"	312-511-230
-------------	-------------

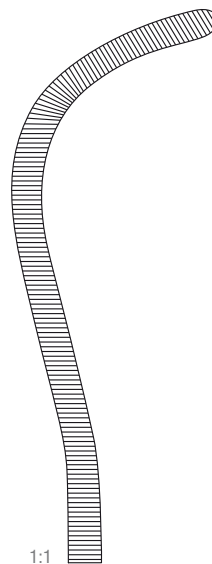

Arterienklemmen

Haemostatic forceps



Klemmzangen – Peritoneumklemmen

Clamp forceps – Peritoneal forceps

Pinces-clamps – Pincés pour le péritoine

Pinzas-clamps – Pinzas para peritóneo

Pinze per peritoneo



1:2

FAURE

200 mm – 8"

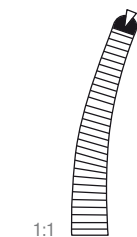

1:1

1 x 2

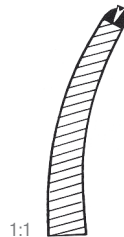

1:1

1 x 2

13-721-210	13-723-210
------------	------------

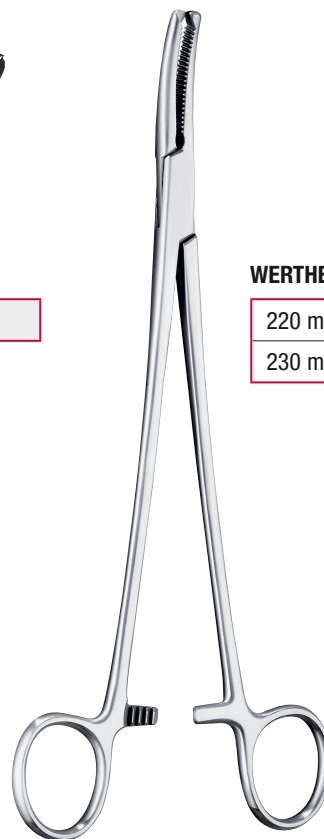

WERTHEIM

220 mm – 8¾"

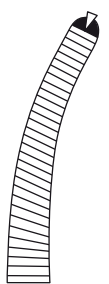

1 x 2

230 mm – 9"

312-569-220	312-571-230
-------------	-------------

Arterienklemmen

Haemostatic forceps

Klemmzangen – Peritoneumklemmen

Clamp forceps – Peritoneal forceps

Pinces-clamps – Pinces pour le péritoine

Pinzas-clamps – Pinzas para peritóneo

Pinze per peritoneo



1:2

PHANEUF

215 mm – 8 ½"

13-280-200

13-281-200

1 x 2

1 x 2

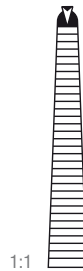

1:1

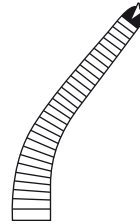

1:1



MOYNIHAN

230 mm – 9"

240 mm – 9 ½"

13-645-225

13-647-235

1:1

1:1

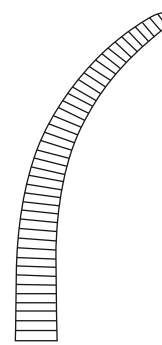
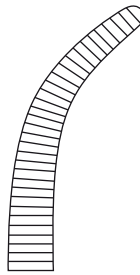

Arterienklemmen

Haemostatic forceps



04

Klemmzangen – Peritoneumklemmen

Clamp forceps – Peritoneal forceps

Pinces-clamps – Pincés pour le péritoine

Pinzas-clamps – Pinzas para peritóneo

Pinze per peritoneo

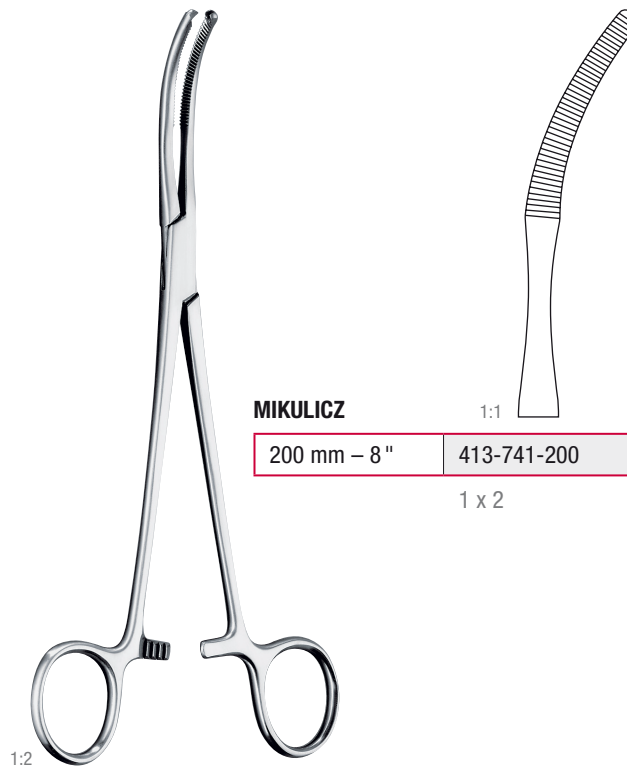
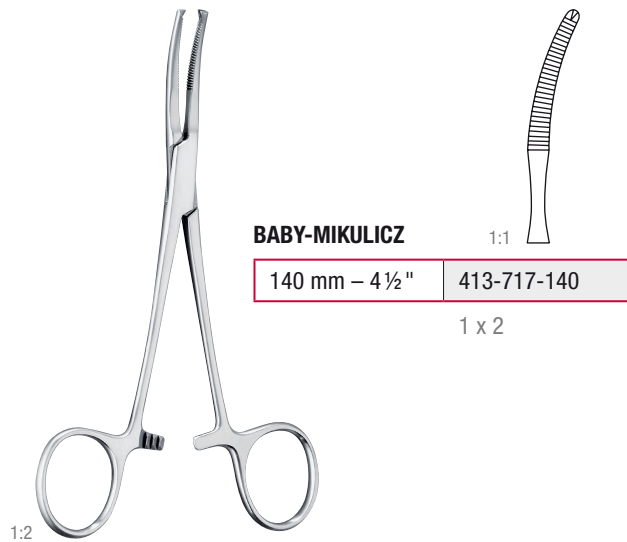

Arterienklemmen

Haemostatic forceps

Klemmzangen – Peritoneumklemmen
Clamp forceps – Peritoneal forceps

Pinces-clamps – Pinces pour le péritoine
Pinzas-clamps – Pinzas para peritóneo
Pinze per peritoneo



MAINGOT

205 mm – 8"	13-685-200
250 mm – 9¾"	13-685-250

1 x 2

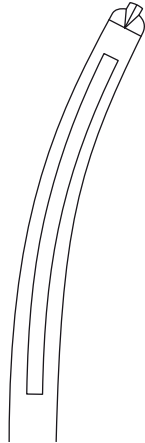

WERTHEIM

250 mm – 9¾"	13-681-250
--------------	------------

1:1

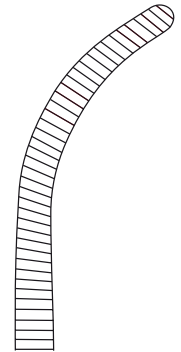

1:2

1:1

WERTHEIM-CULLEN

215 mm – 8½"	312-575-210
--------------	-------------

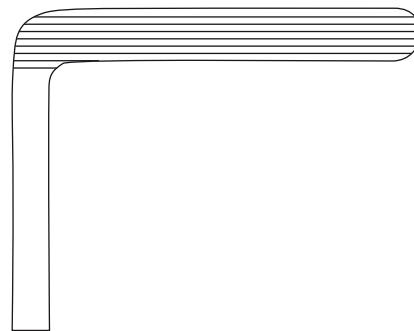

1:2

Arterienklemmen

Haemostatic forceps



04

Hysterektomieklemmen

Hysterectomy forceps

Pinces pour hystérectomie
Pinzas para histerectomía
Pinze per isterectomia



HEANEY

195 mm – 7¾"	13-905-195	13-907-195
210 mm – 8¼"	13-905-210	13-907-210
230 mm – 9"	13-905-230	13-907-230

Arterienklemmen Haemostatic forceps

Hysterektomieklemmen
Hysterectomy forceps

Pinces pour hystérectomie
Pinzas para histerectomía
Pinze per isterectomia

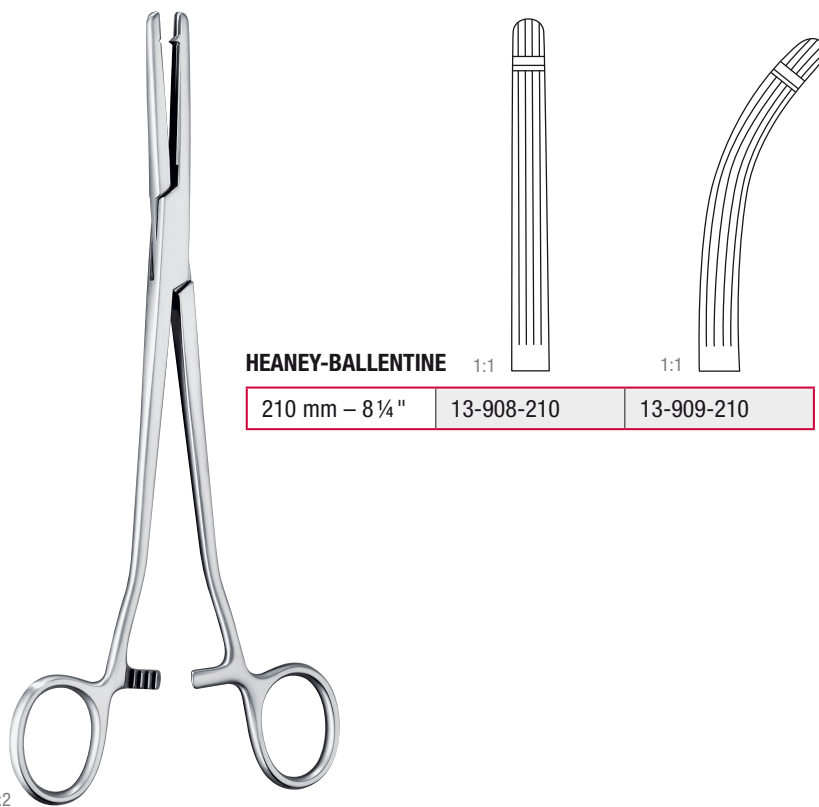

Arterienklemmen

Haemostatic forceps



Parametriumklemmen
Parametrium forceps
Pinces parametrium
Pinzas parametrium
Pinze parametrium

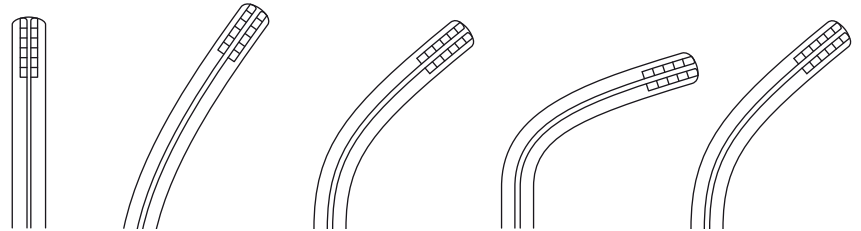

210 mm – 8 ¼"	13-913-210	13-915-210	13-917-210	13-919-210	13-921-210
240 mm – 9 ½"	13-913-240	13-915-240	13-917-240	13-919-240	13-921-240
260 mm – 10 ¼"	13-913-260	13-915-260	13-917-260	13-919-260	13-921-260
300 mm – 12"	13-913-300	13-915-300	13-917-300	13-919-300	13-921-300
350 mm – 13 ¾"	13-913-350	13-915-350	13-917-350	13-919-350	13-921-350

S-förmig gebogen
 S-curved
 coube en S
 curva en S
 curva a forma di S

Arterienklemmen

Haemostatic forceps

Lungenfasszangen

Lung grasping forceps

Pinces-clamps pour poumons

Pinzas para coger pulmones

Pinza per afferrare il polmone

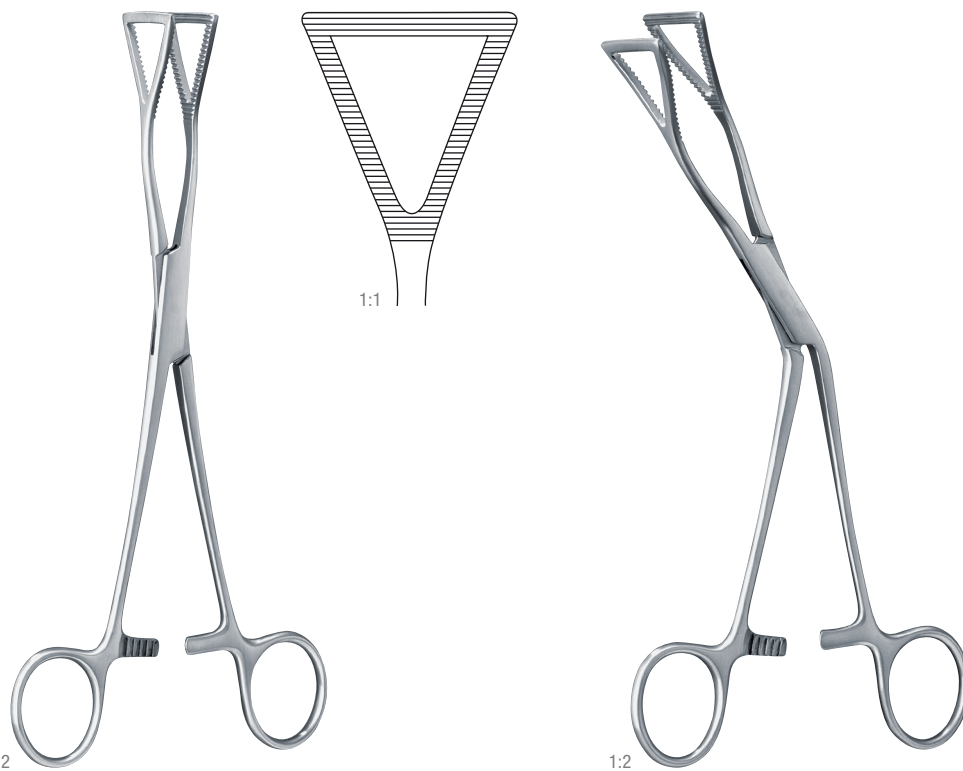

LOVELACE

1:2

1:2

200 mm – 8"

356-286-200

356-287-200

Arterienklemmen

Haemostatic forceps



Bronchus- und Gefäßklemmen

Bronchus and vascular clamps

Pinces vasculaires et pour bronches
Pinzas vasculares y bronquiales
Pinze vascolari e per bronchi



1:2

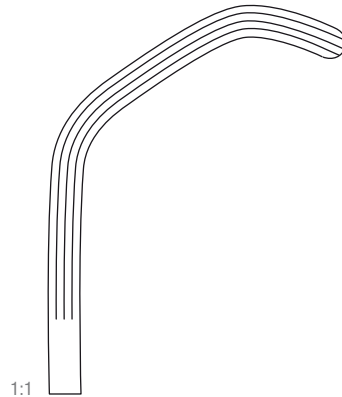

1:1

PRICE-THOMAS

220 mm – 8 3/4"

356-305-220

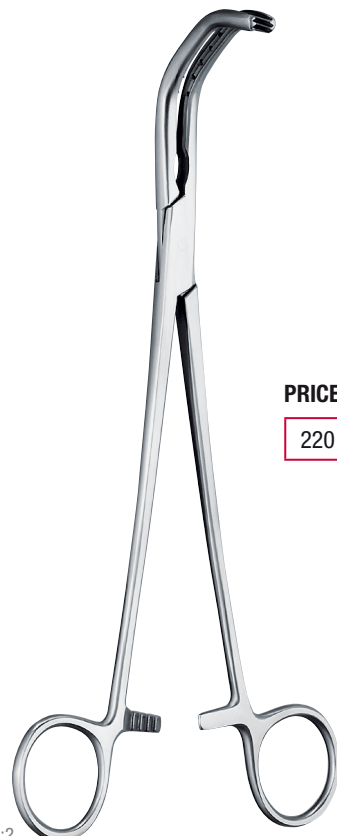

1:2

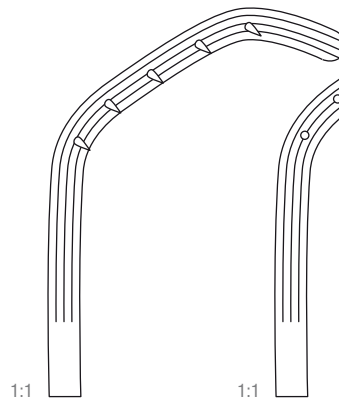

1:1

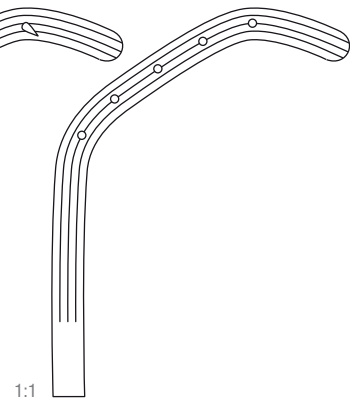

1:1

PRICE-THOMAS

220 mm – 8 3/4"

356-307-220

356-309-220

Stifte links
 Pins left
 Goupilles à gauche
 Pernos izquierda
 Perni a sinistra

Stifte rechts
 Pins right
 Goupilles à droit
 Pernos derecha
 Perni a destra

Arterienklemmen

Haemostatic forceps

Bronchus- und Gefäßklemmen

Bronchus and vascular clamps

Pinces vasculaires et pour bronches
Pinzas vasculares y bronquiales
Pinze vascolari e per bronchi

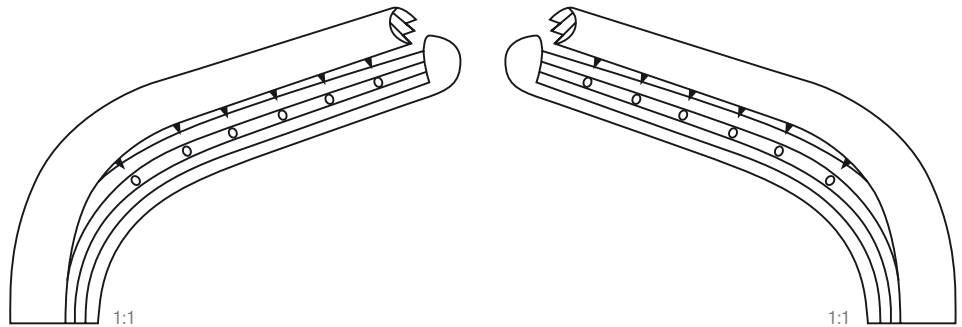

SAROT

230 mm – 9"

356-313-230

356-315-230

Stifte links

Pins left
Goupilles à gauche
Pernos izquierda
Perni a sinistra

Stifte rechts

Pins right
Goupilles à droit
Pernos derecha
Perni a destra

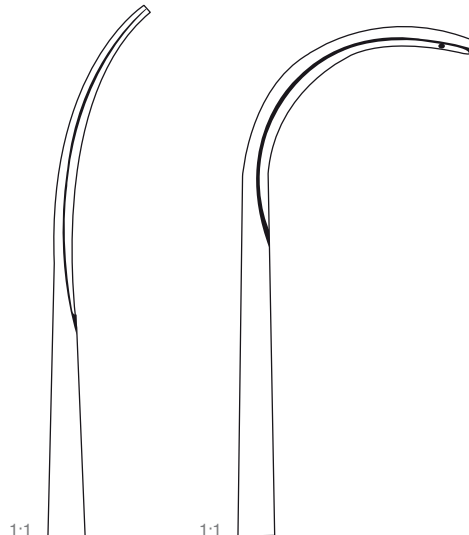

SEMB

1:1

1:1

240 mm – 9½"

356-317-230

356-319-230

Arterienklemmen

Haemostatic forceps



Bronchus- und Gefäßklemmen

Bronchus and vascular clamps

Pinces vasculaires et pour bronches
Pinzas vasculares y bronquiales
Pinze vascolari e per bronchi



BABY-SATINSKY

1:1

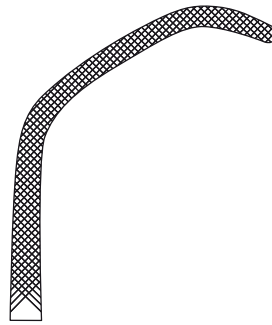

150 mm – 6"

356-321-150



SATINSKY

1:1

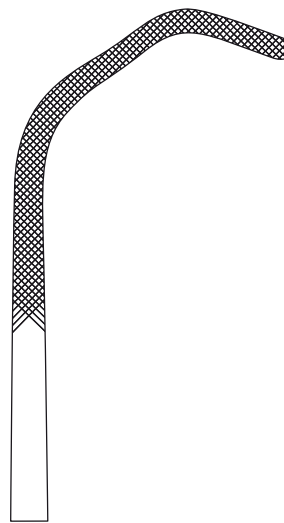

1:1

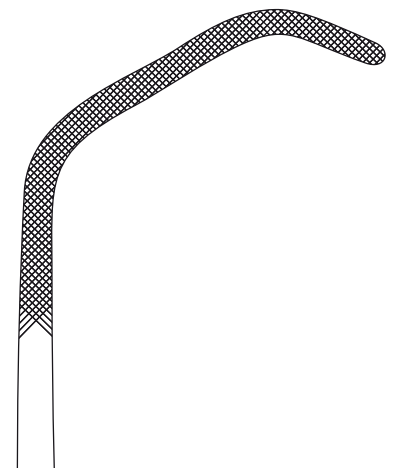

	Fig. 1	Fig. 1	Fig. 2	Fig. 2
265 mm – 10½"	356-323-260	356-327-260	356-325-260	356-329-260

S-förmig gebogen
 S-curved
 coube en S
 curva en S
 curva a forma di S

S-förmig gebogen
 S-curved
 coube en S
 curva en S
 curva a forma di S

Arterienklemmen

Haemostatic forceps

Tuchklemmen

Towel forceps

Pinces à champs

Pinzas de campo

Pinze fissateli



BERNHARD

100 mm – 4 "	314-136-100
120 mm – 4 ¾ "	314-136-120
140 mm – 5 ½ "	314-136-140
165 mm – 6 ½ "	314-136-160
180 mm – 7 "	314-136-180



BACKHAUS

80 mm – 3 "	17-251-080
90 mm – 3 ½ "	17-251-090
110 mm – 4 ¼ "	17-251-110
130 mm – 5 "	17-251-130
150 mm – 6 "	17-251-150



ROEDER

130 mm – 5 "	17-255-130
150 mm – 6 "	17-255-150



1:2

110 mm – 4 "	314-111-110
--------------	-------------

mit Schlauchhalter
with clip for tube
avec porte-tuyeau
con soporte de tubo
con supporto per tubo

Arterienklemmen

Haemostatic forceps



04

Tuchklemmen

Towel forceps

Pinces à champs

Pinzas de campo

Pinze fissateli



ROBIN 1:2

135 mm – 5 ¼"	17-247-135
---------------	------------

mit Schlauchhalter bis 5 mm Ø
with clip for tube up to 5 mm Ø
avec porte-tuyeau à 5 mm Ø
con soporte de tubo hasta 5 mm Ø
con supporto per tubo fino a 5 mm Ø



JONES

50 mm – 2"	17-227-060
90 mm – 3 ½"	17-227-090



SCHAEDEL 1:2

90 mm – 3 ½"	17-221-090	17-220-090
--------------	------------	------------

gerade
straight
droit
recta
retto



DOYEN 1:2

180 mm – 7"	17-229-180
-------------	------------

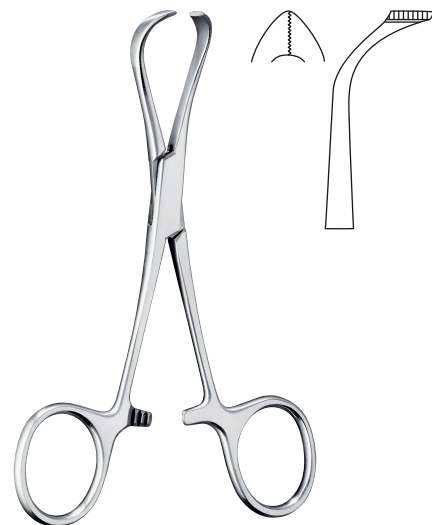

LORNA

100 mm – 4"	17-261-100
130 mm – 5"	17-261-130

Arterienklemmen

Haemostatic forceps

Tuchklemmen

Towel forceps

Pinces à champs

Pinzas de campo

Pinze fissateli



LANE

130 mm – 5"	314-160-130
150 mm – 6"	314-160-150
200 mm – 8"	314-160-200



TOHOKU-JAPAN

100 mm – 4"	413-919-100
130 mm – 5"	413-919-130



1:2

PEERS-BERTRAM

145 mm – 5¾"	413-919-140
--------------	-------------

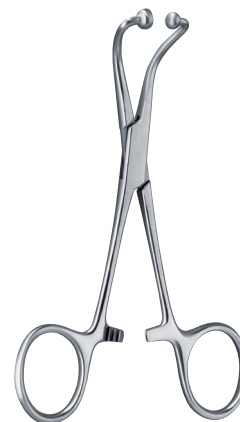

110 mm – 4⅜"	314-119-110
130 mm – 5"	314-119-130

für Papierabdeckung

for paper clothes
pour couvertures en papier
para paños de papel
per copertura di carta

Arterienklemmen

Haemostatic forceps



04

Schlauchklemmen
Tubing clamps
Presse-tubes
Pinzas para tubos
Pinze serratubi



150 mm – 6"	312-706-150
160 mm – 7"	312-706-180
190 mm – 8"	312-706-200

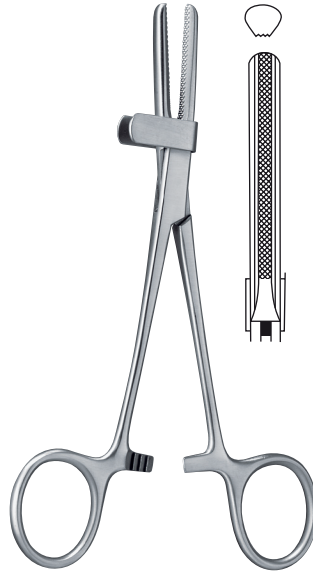

150 mm – 6"	312-708-150
180 mm – 7"	312-708-180
200 mm – 8"	312-708-200

mit **Schutzbügel**
 with protection
 avec protection
 con protector
 con protettore

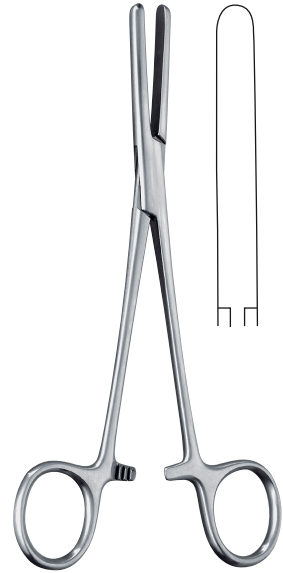

165 mm – 6½"	13-984-165
180 mm – 7"	13-984-180

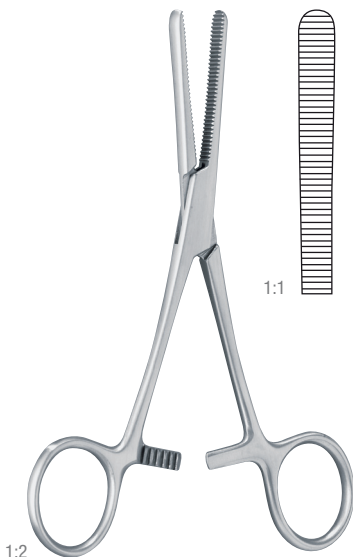

1:2
KLINIKUM-BERLIN

145 mm – 5¾"	13-980-145
--------------	------------

mit **extra langer Sperre**
 with extra long ratchet
 avec crémaillère extra longue
 con cremallera extra larga
 con cremagliera extra lunga



1:2
GUNNAR

185 mm – 7¼"	13-950-180
--------------	------------

